

ДЕКЛАРАЦИЯ ЗА ЕКСПЛОАТАЦИОННИ ПОКАЗАТЕЛИ

в съответствие с Приложение III на Регламент (ЕС) № 305/2011 (Регламент за строителните продукти)

Пожарозащитно устройство за замонолитване Hilti CFS-CID № Hilti CFS-CID

1. Уникален идентификационен код на типа продукт:

Пожарозащитно устройство за замонолитване Hilti CFS-CID

2. Предвидена употреба/употреби:

Пожарозащитен и уплътняващ продукт за уплътнения на прониквания, вижте ETA-20/1233 (20.12.2020 г.)

Точки на проникване на тръби	Пластмасови тръби
	Изолирани метални тръби

3. Производител:

Hilti Corporation, Feldkircherstrasse 100, 9494 Schaan, Княжество Лихтенщайн

4. Система/системи за оценяване и проверка на постоянството на експлоатационните показатели:

Система 1

5. Европейски документ за оценяване:

EAD 350454-00-1104

Европейска техническа оценка:

ETA-20/1233 (20.12.2020 г.)

Орган за техническа оценка:

ETA-DK

Нотифициран орган/органи:

MPA-Braunschweig, № 0761

6. Декларирани експлоатационни показатели:

Съществена характеристика	Декларирани експлоатационни показатели / Хармонизирана техническа спецификация
Реакция на огън	Клас Е съгласно EN 13501-1
Огнеустойчивост	Експлоатационни показатели за огнеустойчивост и област на приложение в съответствие с EN 13501-2. Вижте Приложение
Опасни вещества	Вижте Приложение
Защита срещу шум	Вижте Приложение
Дълготрайност и експлоатационна годност	Y ₂ , в съответствие с EAD 350454-00-1104

Експлоатационните показатели на продукта, посочени по-горе, са в съответствие с декларираните експлоатационни показатели. Настоящата

декларация за експлоатационни показатели се издава в съответствие с Регламент (ЕС) № 305/2011, като отговорността за нея се носи изцяло от

посочения по-горе производител. Подписано за и от името на производителя от:

Дороти Уай
Продуктов ръководител
Филиал Пожарозащита
Hilti Corporation

Мартин Алтоф
Ръководител по качеството
Филиал Пожарозащита
Hilti Corporation

Extract of ETA-20/1233 (20.12.2020)

3 Performance of The Product And References To The Methods Used For Its Assessment

Basic requirements for construction works	Essential characteristics	Method of verification	Performance
BWR 1	None	Not relevant	
BWR 2	Reaction to fire	EN 13501-1	Class E
	Resistance to fire	EN 13501-2:2007+A1:2009	See annex 2
BWR 3	Air permeability (material property)	No performance assessed	
	Water permeability (material property)	No performance assessed	
	Content and/or release of dangerous substances	European Council Directive 67/548/EEC- Dangerous Substances Directive and Regulation (EC) No 1272/2008, see clause 3.3.1	Declaration of conformity by the manufacturer
BWR 4	Mechanical resistance and stability	Not relevant	
	Resistance to impact / movement	No performance assessed	
	Adhesion	See clause 3.4.2	
BWR 5	Airborne sound insulation	See clause 3.5.1	
BWR 6	Thermal properties	No performance assessed	
	Water vapour permeability	No performance assessed	
BWR 7	No performance assessed		

3.1 Safety in case of fire

3.1.1 Reaction to fire

The components of construction product Hilti Firestop Cast-in Device CFS-CID are classified according to EN 13501-1.

Component	Class according to EN 13501-1
CFS-CID	E

3.1.2 Resistance to fire

The resistance to fire performance according to EN 13501-2 of penetration seals made of Hilti Firestop Cast-in Device CFS-CID is given in Annex 2.

3.2 Hygiene, Health, and the environment.

3.2.1. Content and release of Dangerous Substances

Hilti AG have presented a Material Safety Data Sheet according to 91/155 EEC and a declaration that Hilti Firestop Cast-in Device CFS-CID is in compliance with Council Directive 76/769/EEC of 27th July 1976 on the approximation of the laws, regulations and administrative provisions of the Member States relating to restrictions on the marketing and use of certain dangerous substances and preparations (incl. all amendments and adaptations).

In addition to the specific clauses relating to dangerous substances contained in this ETA, there may be other requirements applicable to the products falling within its scope (e.g. transposed European legislation and national laws, regulations and administrative provisions). In order to meet the provisions of the Construction Product Regulation, these requirements need also to be complied with, when and where they apply.

3.3 Safety and accessibility in use

3.3.1 Mechanical resistance and stability

No performance assessed

3.3.2 Resistance to impact/movement

No performance assessed

3.3.3 Adhesion

The fixing of the Cast-in Device must be done according to the provisions given in Annex 3.

3.4 Protection against noise

3.4.1 Airborne sound insulation

Airborne sound insulation for a single penetration of a plastic pipe, fire stopped with Firestop Cast-in Device CFS-CID can only be achieved when the pipe closure device is casted in rigid floor.

Test reports from noise reduction according to EN ISO 10140-1: 2010 + A1: 2012 + A2: 2014, EN ISO 10140-2: 2010 and EN ISO 717-1: 2013 have been provided.

The acoustic tests were performed in a rigid wall. Hilti Firestop Cast-in Device CFS-CID 50, 75, 110 and 160 was tested in combination with a plastic pipe. The acoustic characteristics of the walls itself have not been measured. According to these tests reports the single number ratings are:

Rigid floor:

Assessed standard level difference:

CFS-CID 50 and plastic pipe: $D_{n,e,w} (C; C_{tr}) = 55 (-3;-2)$ dB

CFS-CID 50 blank version: $D_{n,e,w} (C; C_{tr}) = 62 (-1;-2)$ dB

CFS-CID 75 and plastic pipe: $D_{n,e,w} (C; C_{tr}) = 51 (-1;-1)$ dB

CFS-CID 75 blank version: $D_{n,e,w} (C; C_{tr}) = 56 (-1;-2)$ dB

CFS-CID 110 and plastic pipe: $D_{n,e,w} (C; C_{tr}) = 48 (-1;0)$ dB

CFS-CID 110 blank version: $D_{n,e,w} (C; C_{tr}) = 53 (-1;-2)$ dB

CFS-CID 160 and plastic pipe: $D_{n,e,w} (C; C_{tr}) = 46 (0;0)$ dB

CFS-CID 160 blank version: $D_{n,e,w} (C; C_{tr}) = 45 (-3;-5)$ dB

From this $D_{n,e,w}$ the assessed standard level calculates to: $R_w (C;C_{tr}) = 61 (-3;-7)$ dB

Structure of the rigid wall: 150 mm thick concrete wall with a density of 2000 kg/m³

It should be noticed that both above mentioned results apply to the total wall construction of the size

$S = 1,23 \text{ m} \times 1,48 \text{ m} (= 1,82 \text{ m}^2)$.

$D_{n,e,w}$: Assessed standard level difference of small building elements (given with spectrum adaptation terms C and C_{tr})

R_w : Assessed standard level (given with spectrum adaptation terms C and C_{tr})

ANNEX 1

DESCRIPTION OF THE PRODUCT AND ANCILLARY PRODUCT(S)

Hilti Firestop Cast-in Device CFS-CID

The Cast-in device consists of a plastic housing, an inlay with different number of intumescent layers, and a rubber gasket.

In case of greater floor thicknesses (>150mm) the Cast-in device length can be increased through an extension tube.

Manifold adapter to create a spacing of 280 x 280 x 75 mm.

A detailed specification of the product is contained in document "Identification / Product Specification relating to the European technical assessment ETA – 16/0383 Hilti Firestop Cast-in Device CFS-CID" which is a non-public part of this ETA.

The Control Plan defined in document "Control Plan is relating to the European technical assessment ETA – 16/0383 Hilti Firestop Cast-in Device CFS-CID" which is a non-public part of this ETA.

Technical product literature:

Installation instruction Hilti Firestop Cast-in Device CFS-CID (according to Annex 3).

ANNEX 2

RESISTANCE TO FIRE CLASSIFICATION OF PENETRATION SEALS MADE OF HILTI FIRESTOP Cast-in Device CFS-CID

Overview intended use of pipes¹ and reference to relevant section

Application	Pipe material	Standard	Insulation	Diameter (mm)	Distance (s _i) (mm)	Fire resistance Classification	Rigid floor
							≥ 550 kg/m ³
							Details (see section)
Waste water Roof Drainage	PE (PE-HD)	EN 1519-1, EN 12666-1 (covers EN 12201-2, EN 1519-1, EN 12666-1, EN 1455-1 (ABS), EN 1565-1 (SAN+PVC))	-	40 - 160	200	EI 180	2.2.1.1
					0	EI 120	
	PE	EN ISO 15494, DIN 8074	-	50 - 160	200	EI 180	2.2.1.2
					0	EI 120	
	PE-S2 Geberit dB20	Non regulated	-	56 - 160	200	EI 180	2.2.2
					0	EI 120	
	PVC-U	EN 1329-1 or EN 1453-1 or EN 1452-1 (covers EN 1329-1, EN 1453-1, EN 1566-1), EN ISO 15493 (Industrial, equivalent EN 1452)	-	63 - 160	200	EI 180	2.2.3
					50 - 160	0	EI 120
	PP	EN 1451-1 (DIN 4102)	-	40 - 160	200	EI 180	2.2.5
					0	EI 120	
Drinking water	PP-R	DIN 8077/8078	-	32 - 160	200	EI 180	2.2.6
	PE-Xa	Non-regulated (Rehau Rautitan Flex)	-	32 - 63	200	EI 180	2.2.7
					0	EI 120	
PE-X	Non-regulated (e.g. Geberit Mepla, etc.)	Elastomeric	40	200	EI 180	2.2.8	
				0	EI 120		

¹ According to technical literature of pipe manufacturers

Application	Pipe material	Standard	Insulation	Diameter (mm)	Distance (s ₁) (mm)	Fire resistance Classification	Rigid floor
							≥ 550 kg/m ³
							Details (see section)
Heating	Copper and Steel	DIN 1786/1754,	Elastomeric	18 - 76	200	EI 180	2.2.9
					200	EI 120	2.2.10
			Glass wool	18 - 76	0	EI 120	2.2.11
					Mineral wool	18 - 89	200
Elbow	PE (PE-HD)	EN 1519-1, EN 12666-1 (covers EN 12201-2, EN 1519-1, EN 12666-1, EN 1455-1 (ABS), EN 1565-1 (SAN+PVC))	-	110			200
	PVC	EN 1519-1, EN 12666-1 (covers EN 12201-2, EN 1519-1, EN 12666-1, EN 1455-1 (ABS), EN 1565-1 (SAN+PVC))					
Blank	-	-	-	-	200	EI 180	2.2.14
					0	EI 120	2.2.15
Manifold	-	-	-	-	200	EI 180	3.1

2.1 General information

2.1.1 Rigid floor

The floor must have a minimum thickness of 150 mm and comprise concrete with a minimum density of 550 kg/m³.

2.1.2 Penetration seal:

Single penetration;

Hilti Firestop Cast-In CFS-CID on the underside of the floor

2.1.3 Distance between penetrations:

Minimum distance between Cast-In / annular gap edge (s₁):

A: Non-insulated pipes: s₁ (0 mm)

Insulated pipes: s₁ (0 mm)

B: Non-insulated pipes: s₁ (200 mm)

Insulated pipes: s₁ (200 mm)

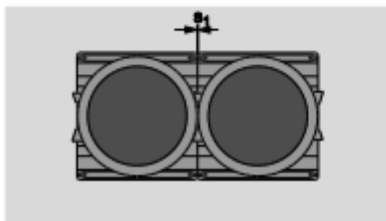

Note: s₁ (0 mm) = EI 120

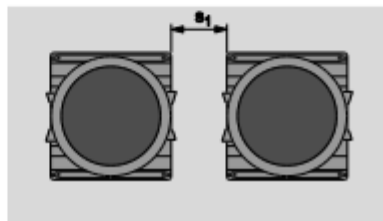

s₁ (200 mm) = EI 180

2.1.4.1 Pipes provided with foamed elastomeric insulation.

The following types of foamed elastomeric insulation material may be used in direct contact

(s₁ ≥ 0 mm) to Hilti Firestop Cast-in Device CFS-CID:

Producer	Approved Type of foamed elastomeric thermal isolation
Armacell GmbH	<ul style="list-style-type: none">• Armaflex AF, Armaflex SH, Armaflex Ultima, Armaflex HT
NMC Group	<ul style="list-style-type: none">• Insul-Tube (nmc), Insul-Tube H-Plus (nmc),
Kaimann GmbH	<ul style="list-style-type: none">• Kaiflex KK plus, Kaiflex KK,
L'Isolante K-Flex	<ul style="list-style-type: none">• l'Isolante K-Flex HT, l'Isolante K-Flex ECO, l'Isolante K-Flex ST, l'Isolante K-Flex H, l'Isolante K-Flex ST Plus

Named material may be used in form of an insulation hose, bandage/wrap or plates. If a

protect insulation D_p is used, it should be made of the same elastomeric material as the thermal pipe isolation itself.

2.1.4.2 Pipes provided with stone wool insulation.

Type	Mineral wool insulation
Form	<ul style="list-style-type: none"> • Half shell, coated with aluminium foil
Reaction to fire classification (EN 13501-1)	<ul style="list-style-type: none"> • A2
Material	<ul style="list-style-type: none"> • Mineral stone wool
Density	<ul style="list-style-type: none"> • $\geq 70 \text{ kg/m}^3$
Melting point	<ul style="list-style-type: none"> • $\geq 1000 \text{ C}^\circ$

2.1.4.3 Pipes provided with glass wool fibre insulation.

Typ	Glass wool insulation
Form	<ul style="list-style-type: none"> • Half shell, coated with aluminium foil
Reaction to fire classification (EN 13501-1)	<ul style="list-style-type: none"> • A2
Material	<ul style="list-style-type: none"> • Mineral glass wool
Density	<ul style="list-style-type: none"> • $\geq 35 \text{ kg/m}^3$

Pipe insulation

Local/Sustained pipe insulation (LS)

Continued/Sustained pipe insulation (CS)

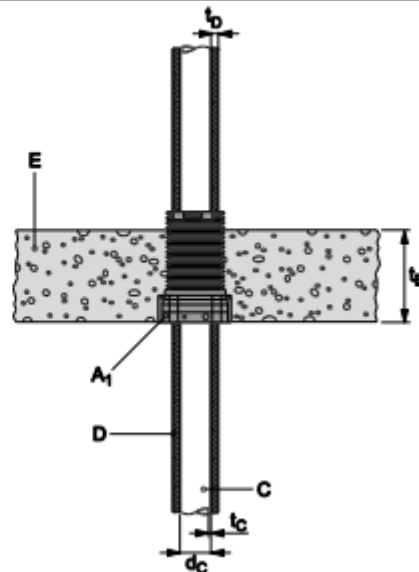
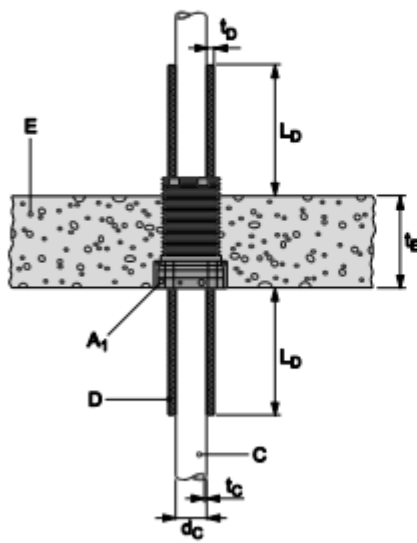

for abbreviations see Annex 4.1

2.2 Penetrating services approved with CFS-CID

2.2.1 PE pipes

Pipe end configuration: U/U

Distance of penetrations (s_1): 200 mm

2.2.1.1 PE pipes according to EN 1519-1, EN 12666-1, EN 12201-2

Pipe end configuration: U/U

Distance of penetrations (s_1): 0mm / 200 mm (B)

Collar size (A_1)	Pipe diameter d_c (mm)	Pipe wall thickness t_c (mm)	Classification with Distance (s_1) 0mm	Classification with Distance (s_1) 200mm
CFS-CID 50	40	3,0	EI 120-U/U	EI 180-U/U
	50	3,0		
	63	3,0		
	40 - 63	3,0		
CFS-CID 75	75	3,0		
CFS-CID 110	90	3,5		
	110	4,2		
	90 - 110	3,5/4,2 ⁽¹⁾		
CFS-CID 160	125	4,8		
	160	6,2		
	125 - 160	4,8/6,2 ⁽¹⁾		

⁽¹⁾ interpolation of min. pipe wall thickness within pipe diameter range

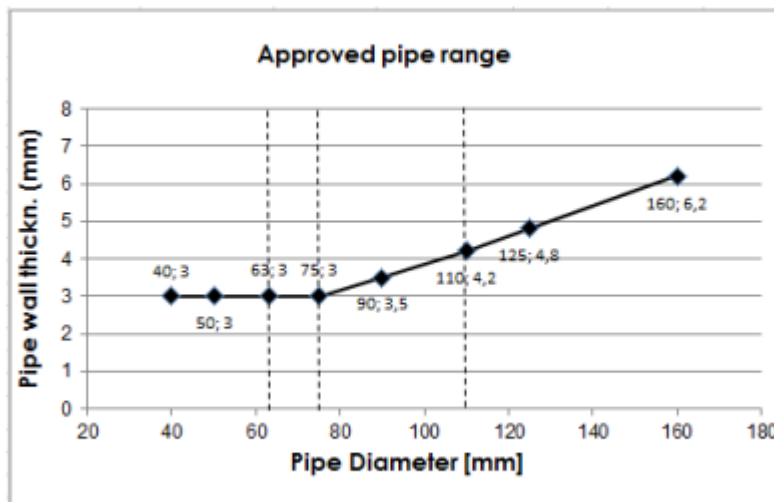

2.2.1.2 PE pipes according to EN ISO 15494 and DIN 8074/8075

Pipe end configuration: U/C

Distance of penetrations (s_1): 0mm / 200 mm (B)

Collar size (A_1)	Pipe diameter d_c (mm)	Pipe wall thickness t_c (mm)	Classification with Distance (s_1) 0mm	Classification with Distance (s_1) 200mm
CFS-CID 50	50	2,9	EI 120-U/U	EI 180-U/U
	63	1,8		
	63	8,6		
	50 - 63	1,8/1,8⁽¹⁾ - 8,6		
CFS-CID 75	75	1,9		
	75	6,8		
	75	1,9⁽¹⁾ to 6,8		
CFS-CID 110	90	2,2		
	110	2,7		
	110	10,0		
	90 - 110	2,2/2,7⁽¹⁾ - 10,0		
CFS-CID 160	125	3,1		
	160	4,0		
	160	9,1		
	125 - 160	3,1/4,0⁽¹⁾ - 9,1		

⁽¹⁾ interpolation of min. pipe wall thickness within pipe diameter range

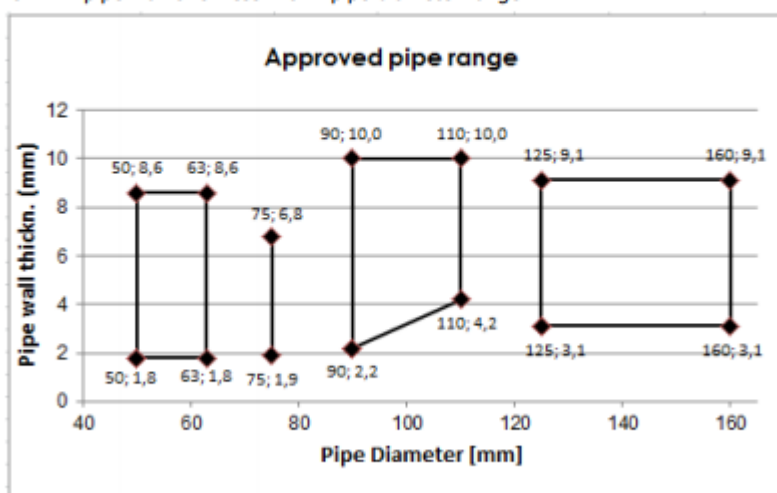

2.2.2 PE-S2 pipes, designation "Geberit Silent dB20"

Pipe end configuration: U/U

Distance of penetrations (s_1): 0mm / 200 mm (B)

Collar size (A_1)	Pipe diameter d_c (mm)	Pipe wall thickness t_c (mm)	Classification with Distance (s_1) 0mm	Classification with Distance (s_1) 200mm
CFS-CID 50	56	3,2	EI 120-U/U	EI 180-U/U
CFS-CID 75	56	3,2		
	75	3,6		
	56 - 75	3,2/3,6⁽¹⁾		
CFS-CID 110	90	5,5		
	110	6,0		
	90 - 110	5,5/6,0⁽¹⁾		
CFS-CID 160	135	6,0		
	160	7,0		
	135 - 160	6,0/7,0⁽¹⁾		

⁽¹⁾ interpolation of min. pipe wall thickness within pipe diameter range

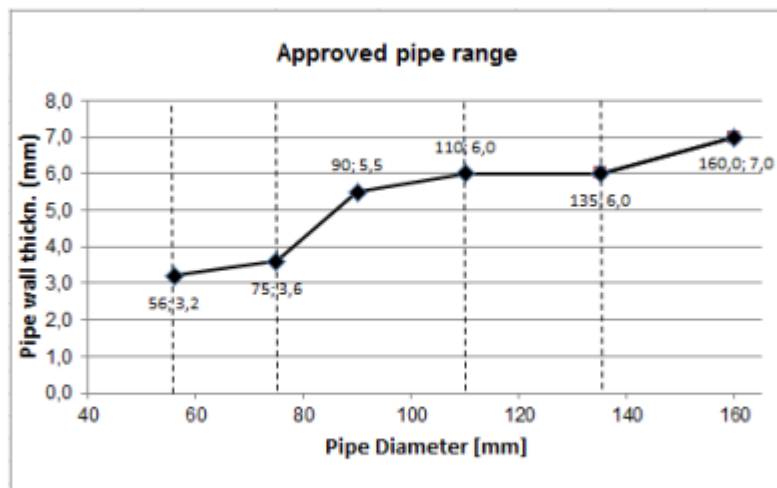

2.2.3 PVC pipes acc. to EN 1452-2, EN 1329-1, EN 1453-1

Pipe end configuration: U/U

Distance of penetrations (s_1): 200 mm (B)

Collar size (A_1)	Pipe diameter d_c (mm)	Pipe wall thickness t_c (mm)	Classification with Distance (s_1) 200mm
CFS-CID 50	63	1,6	EI 180-U/U
	63	7,0	
	63	1,6 - 7,0	
CFS-CID 75	75	8,4	
CFS-CID 110	80	1,8	
	110	8,1	
	80 - 110	1,8/8,1⁽¹⁾	
CFS-CID 160	125	1,8	

⁽¹⁾ interpolation of min. pipe wall thickness within pipe diameter range

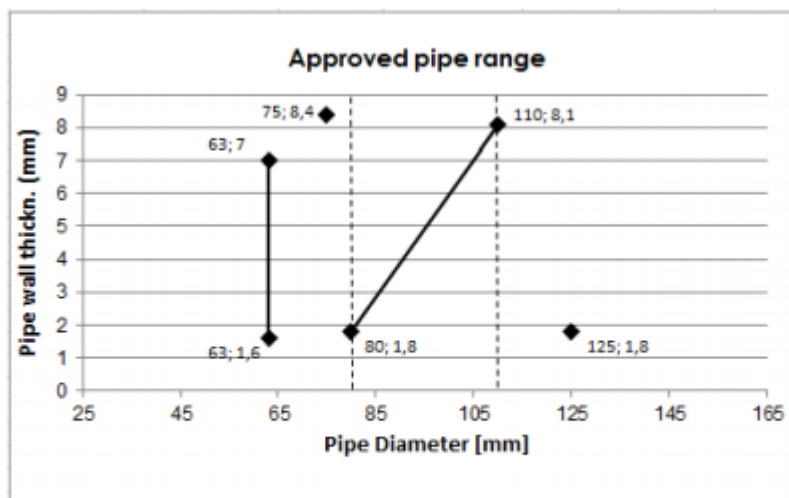

2.2.4 PVC pipes acc. to EN 1452-2, EN 1329-1, EN 1453-1

Pipe end configuration: U/U

Distance of penetrations (s_1): 0 mm (A)

Collar size (A_1)	Pipe diameter d_c (mm)	Pipe wall thickness t_c (mm)	Classification with Distance (s_1) 0mm
CFS-CID 50	50	2,4	EI 120-U/U
	63	1,6	
	63	7,0	
	50 - 63	1,6/1,6⁽¹⁾ - 7,0	
CFS-CID 75	75	2,2	
	75	8,4	
	75	2,2 - 8,4	
CFS-CID 110	80	1,8	
	110	1,8	
	110	8,1	
	80 - 110	1,8/1,8⁽¹⁾ - 8,1	
CFS-CID 160	125	1,8	
	160	3,2	
	160	7,7	
	125 - 160	1,8/3,2⁽¹⁾ - 7,7	

⁽¹⁾ interpolation of min. pipe wall thickness within pipe diameter range

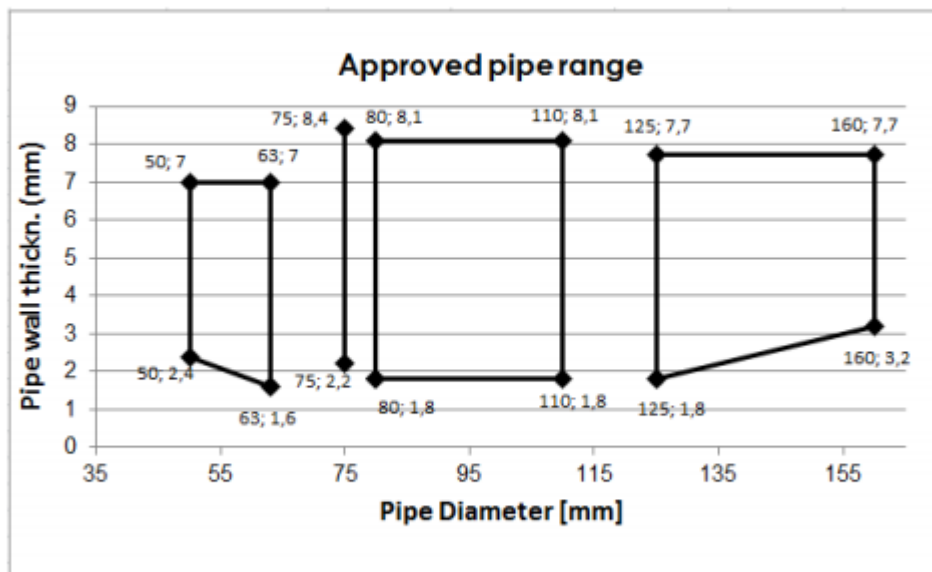

2.2.5 PP pipes according to EN 1451-1

Designation: Cloes "Blue Power", Cloes "PhoNoFire", "Geberit Silent PP", Marley Silent, Ostendorf "Skolan-dB", Pipelife "Master 3", POLOPLAST "Polokal NG", "POLOPLAST Phonex AS", POLOPLAST "Polokal 3S", "POLOPLAST Polokal XS", Rehau "Raupiano Plus", Wavin "AS", KeKelit "Phonex AS", Wavin "SiTech", Valsire "Triplus", Valsire "Silere",

Pipe end configuration: U/U

Distance of penetrations (s_1): 0mm / 200 mm (B)

Collar size (A_1)	Pipe diameter d_c (mm)	Pipe wall thickness t_c (mm)	Classification with Distance (s_1) 0mm	Classification with Distance (s_1) 200mm
CFS-CID 50	40	1,8	EI 120-U/U	EI 180-U/U
	50	1,8		
	58	4,0		
	40 - 58	1,8 - 1,8/4,0⁽¹⁾		
CFS-CID 75	50	1,8		
	75	3,8		
	50 - 75	1,8/3,8⁽¹⁾		
CFS-CID 110	90	2,2		
	90	4,5		
	110	2,7		
	110	4,8		
	110	5,3		
	90 - 110	2,2/2,7⁽¹⁾ - 5,3		
CFS-CID 160	125	3,1		
	160	3,9		
	160	7,5		
	125 - 160	3,1/3,9⁽¹⁾ - 7,5		

⁽¹⁾ interpolation of min. pipe wall thickness within pipe diameter range

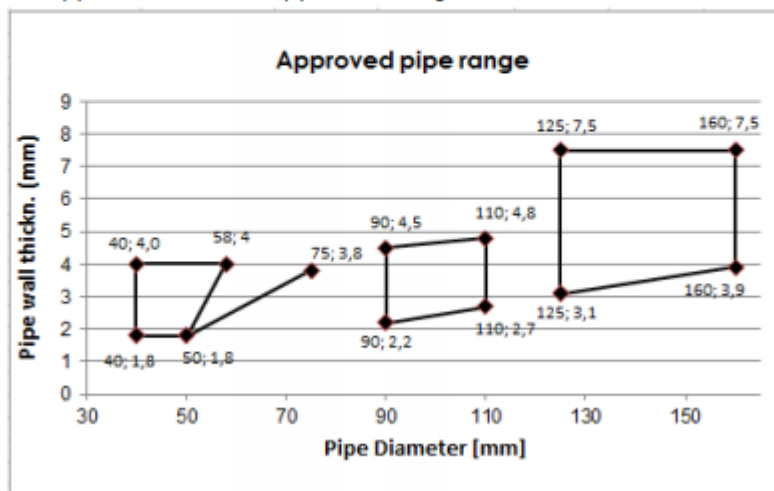

2.2.6 PP-R pipes designation "Aquatherm"

Pipe end configuration: U/C

Distance of penetrations (s_1): 200 mm (B)

Collar size (A_1)	Pipe diameter d_c (mm)	Pipe wall thickness t_c (mm)	Classification with Distance (s_1) 200mm
CFS-CID 50	32	2,9	EI 180-U/C
	50	4,6	
	63	5,8	
	32 - 63	2,9/5,8 ⁽¹⁾	
CFS-CID 75	75	6,8	
	75	10,7	
	75	6,8 - 10,7	
CFS-CID 110	90	8,2	
CFS-CID 160	160	14,6	

⁽¹⁾ interpolation of min. pipe wall thickness within pipe diameter range

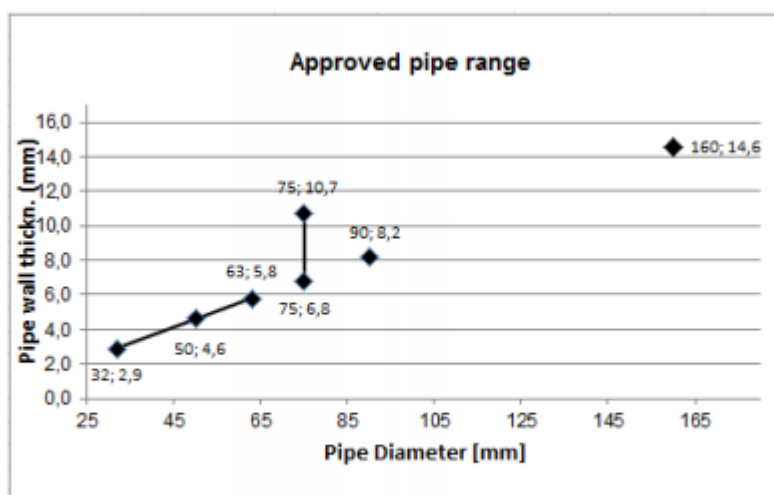

2.2.7 PE-Xa pipes designation "Rehau Rautitan Flex"

Pipe end configuration: U/U

Distance of penetrations (s₁): 200 mm (B)

Collar size (A ₁)	Pipe diameter d _c (mm)	Pipe wall thickness t _c (mm)	Classification with Distance (s ₁) 200mm
CFS-CID 50	32	4,0	EI 180-U/U
	50	6,9	
	63	8,6	
	32 - 63	4,4/8,6 ⁽¹⁾	

⁽¹⁾ interpolation of min. pipe wall thickness within pipe diameter range

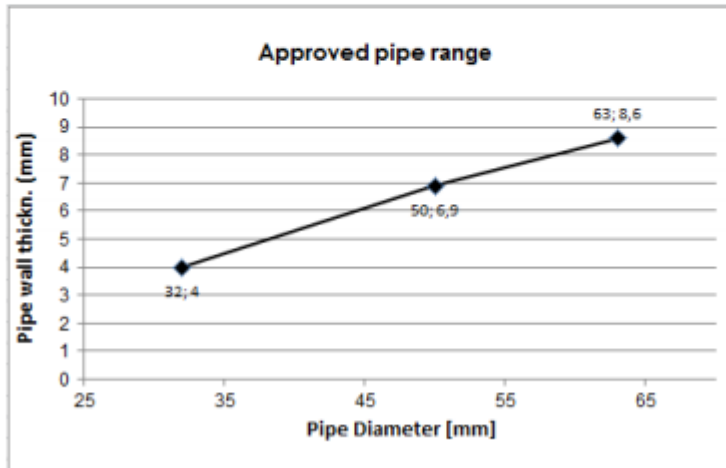

2.2.8 PE-X pipes designation "Geberit Mepla", elastomeric foamed thermal pipe insulation,

Pipe end configuration: U/U

Distance of penetrations (s₁): 200 mm (B)

Collar size (A ₁)	Pipe diameter d _c (mm)	Pipe wall thickness t _c (mm)	Pipe insulation thickness (mm), CS	Classification with Distance (s ₁) 200mm
CFS-CID 50	40	3,5	9,0	EI 180-U/U

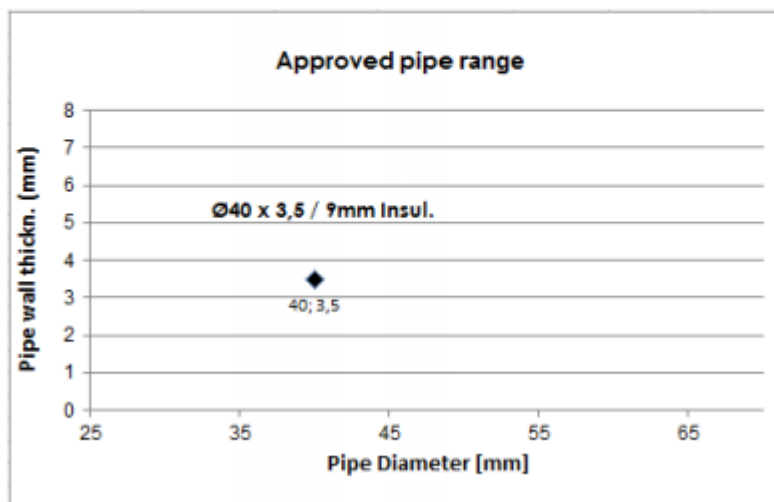

2.2.9 Copper pipes including metal pipes, sustained (CS) elastomeric foamed thermal pipe insulation

Pipe end configuration: C/U

Distance of penetrations (s_1): 200 mm (B)

Collar size (A_1)	Pipe diameter d_c (mm)	Pipe wall thickness t_c (mm)	Pipe insulation thickness (mm)	Classification with Distance (s_1) 200mm
CFS-CID 50	18	1,0	8,0	EI 180-C/U
	28	1,5	19,0	
CFS-CID 75	18	1,0	32,0	
CFS-CID 110	42	1,5	36,5	
	54	2,0	17,0	
CFS-CID 160	54	2,0	38,0	
	76	2,0	30,0	

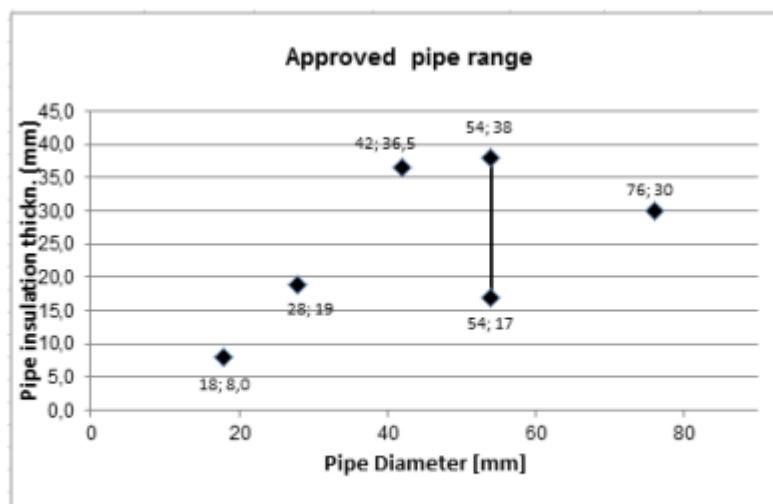

**2.2.10 Copper pipes including metal pipes,
with sustained (CS) elastomeric foamed thermal pipe insulation**

Pipe end configuration: C/U

Distance of penetrations (s_1): 200 mm (B)

Collar size (A_1)	Pipe diameter d_c (mm)	Pipe wall thickness t_c (mm)	Pipe insulation thickness (mm)	Classification with Distance (s_1) 200mm
CFS-CID 50 CFS-CID 75 CFS-CID 110 CFS-CID 160	18 - 54	1,0/2,0 ⁽¹⁾	8,0 - 38,0 ⁽³⁾	EI 120-C/U
	64 - 76	1,0/2,0 ⁽¹⁾	14,0 - 30,0 ⁽³⁾	

⁽¹⁾ interpolation of min. pipe wall thickness within pipe diameter range

⁽³⁾ interpolation of min. pipe insulation within pipe diameter range

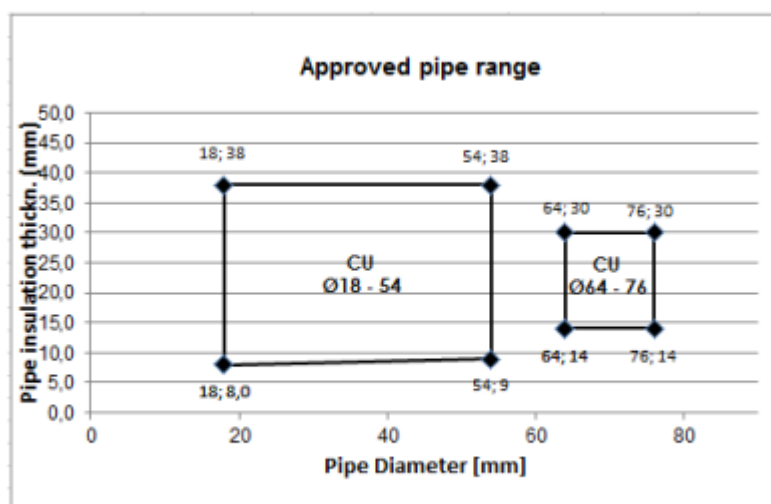

**2.2.11 Copper pipes including metal pipes,
with local sustained (LS) mineral glass wool thermal pipe insulation**
Pipe end configuration: C/U
Distance of penetrations (s_1): 200 mm (B)

Collar size (A ₁)	Pipe diameter d _c (mm)	Pipe wall thickness t _c (mm)	Pipe insulation thickness (mm)	Classification with Distance (s ₁) 200mm
CFS-CID 50	18	1,0	20,0	EI 120-C/U
CFS-CID 75	35	1,5	20,0	
CFS-CID 110	76	2,0	20,0	

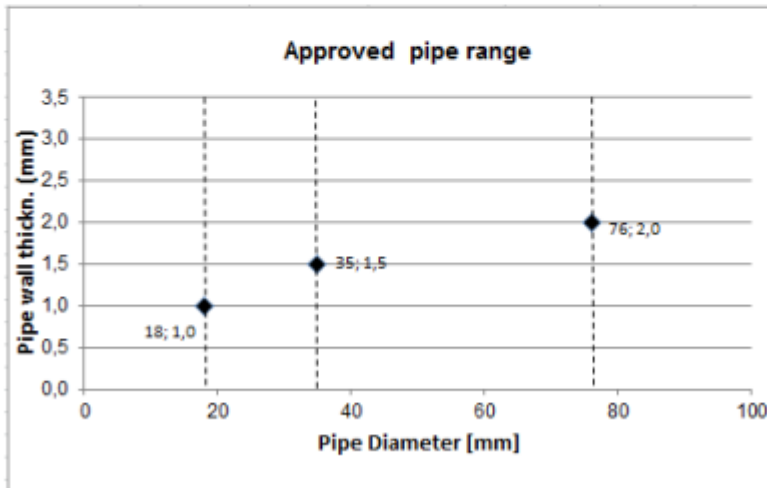

**2.2.12 Copper pipes including metal pipes,
with local sustained (LS) mineral stone wool thermal pipe insulation
Pipe end configuration: C/U
Distance of penetrations (s₁): 200 mm (B)**

Collar size (A ₁)	Pipe diameter d _c (mm)	Pipe wall thickness t _c (mm)	Pipe insulation thickness (mm)	Classification with Distance (s ₁) 200mm
CFS-CID 50	18	1,0	20,0	EI 180-C/U
CFS-CID 75	35	1,5	20,0	
CFS-CID 110	76	2,0	20,0	
CFS-CID 160	89	2,0	20,0	

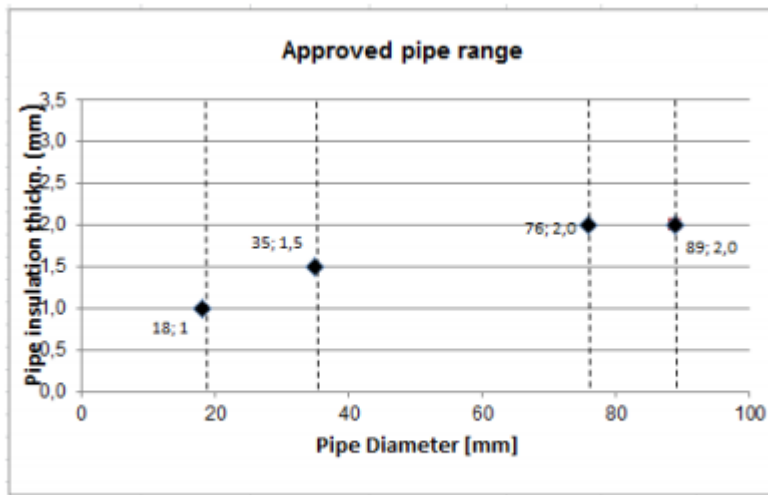

**2.2.13 PE pipes according to EN 1519-1, EN 12666-1, EN 12201-2 with 87° elbow,
PVC pipes acc. to EN 1452-2, EN 1329-1, EN 1453-1 with 87° elbow
Pipe end configuration: U/U
Distance of penetrations (s₁): 200 mm (B)**

Collar size (A ₁)	Pipe diameter d _c (mm)	Pipe wall thickness t _c (mm)	Classification with Distance (s ₁) 200mm
CFS-CID 110	110	4,2	EI 180-U/U

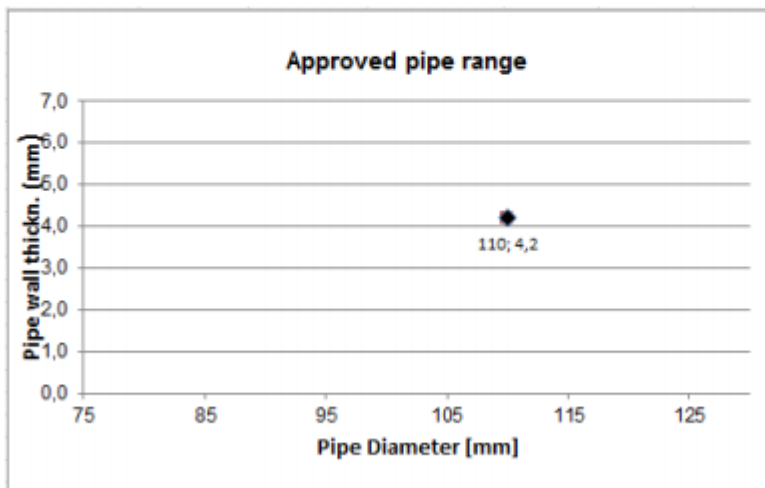

2.2.14 Blank seals**Distance of penetrations (s_1): 0mm / 200 mm (B)**

Collar size (A_1)	Classification with Distance (s_1) 0mm	Classification with Distance (s_1) 200mm
CFS-CID 50	EI 120-U/U	EI 180-U/U
CFS-CID 75		
CFS-CID 110		
CFS-CID 160		

3.1 Penetrating services approved for CFS-CID with "Manifold"

The floor must have a minimum thickness of 150 mm and comprise concrete with a minimum density of 550 kg/m³.

Penetration seal:

- Pipes classified in the section 2.2.1 to 2.2.20 can be sealed with a Hilti Firestop Cast-in device CFS-CID with a Manifold adapter if the requirements of the options a) or b) given below are respected (the conditions to expose the intumescent layer of the Cast-in device to a potential fire have to be maintained):
 - a) the bottom side of the Cast-in device A_1 must be installed flush with the bottom side of the floor, the manifold A_2 is positioned on top of the Cast-in device
 - b) the bottom side of the manifold A_2 must be installed flush with the bottom side of the floor, the Cast-in device A_1 is positioned directly on top of the manifold
- the remaining floor thickness t_E around the Cast-in device must be ≥ 150 mm

Manifold:

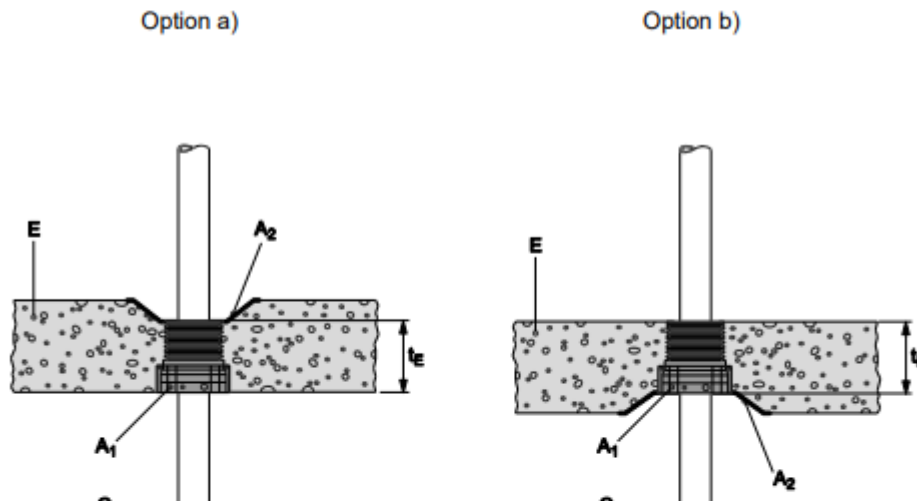

ANNEX 4

ABBREVIATIONS AND REFERENCE DOCUMENTS

4.1 Abbreviations used in drawings

Abbreviation	Description
A ₁	Hilti Firestop Cast in CFS-CID
A ₂	Manifold
C	Plastic Pipe
D	Pipe insulation
d _c	Pipe diameter (nominal outside diameter)
E	Building element (wall, floor)
s ₁	Minimum distance between single penetration seals
t _c	Pipe wall thickness
t _b	Insulation thickness
t _e	Thickness of the building element
L _b	Length of Insulation