

HILTI

DX 2

사용설명서

ko

操作说明书

cn

Operating instructions

en

Инструкция по эксплуатации

ru

Návod k obsluze

cs

Návod na obsluhu

sk

Használati utasítás

hu

Kullanma Talimatı

tr

دليل الاستعمال

ar



1



2

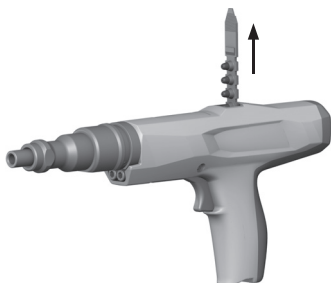

3

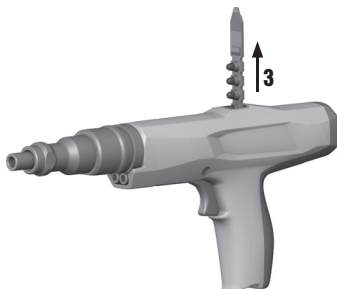
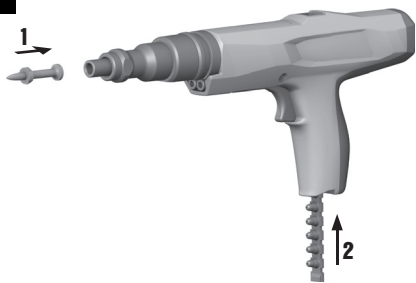

4

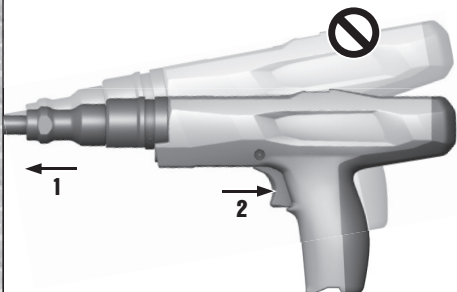
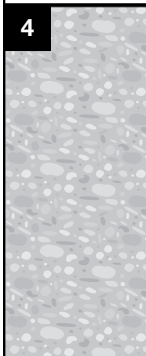

5

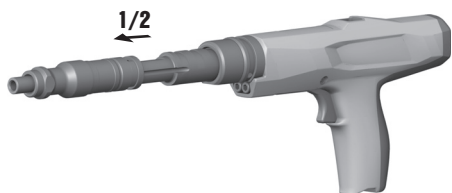

6

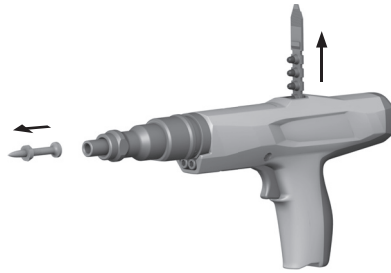

7

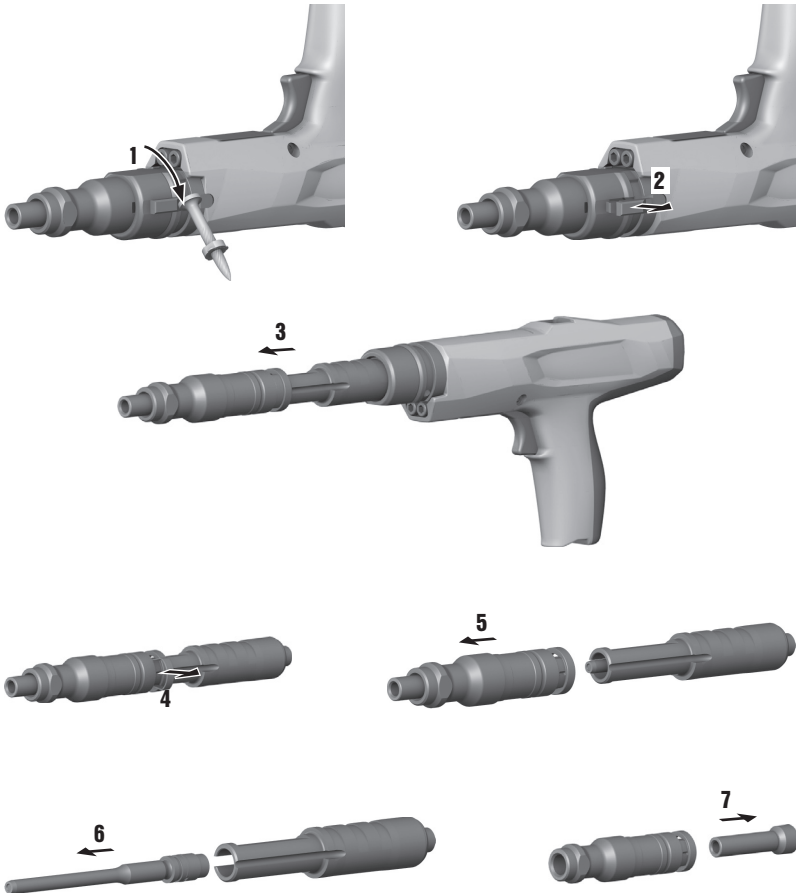

8

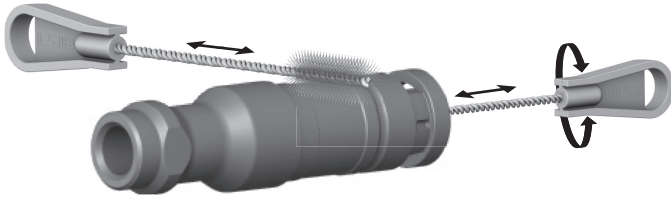

9

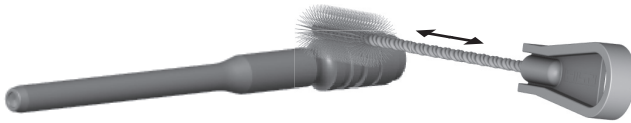

10

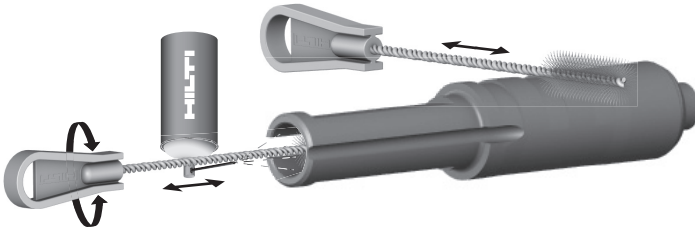

11



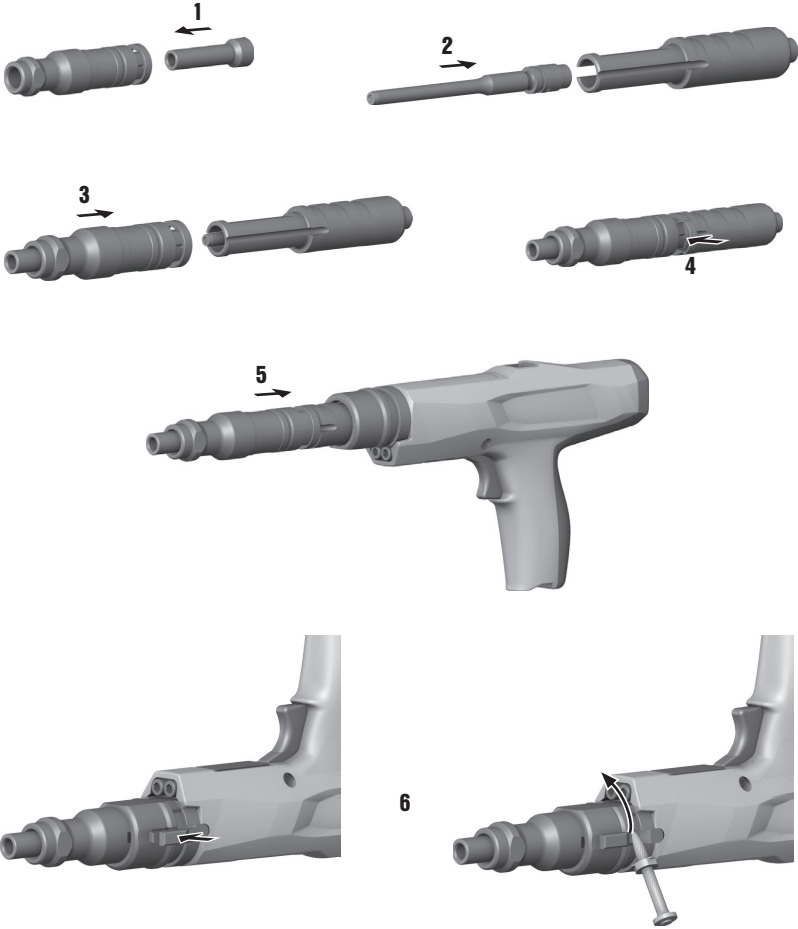

DX 2 powder-actuated fastening tool

It is essential that the operating instructions are read before the tool is operated for the first time.

Always keep these operating instructions together with the tool.

Ensure that the operating instructions are with the tool when it is given to other persons.

Contents	Page
1 Safety instructions	28
2 General information	30
3 Description	31
4 Accessories, consumables	32
5 Technical data	32
6 Before use	32
7 Guidelines	33
8 Operation	34
9 Care and maintenance	35
10 Troubleshooting	36
11 Disposal	40
12 Manufacturer's warranty - tools	40
13 EC declaration of conformity (original)	41
14 Confirmation of CIP testing	41
15 Health and safety of the operator	41

I These numbers refer to the illustrations. You can find the illustrations at the beginning of the operating instructions.

In these operating instructions, the designation "the tool" always refers to the DX 2 powder-actuated fastening tool.

Parts and operating controls **I**

- ① Casing
- ② Piston guide
- ③ Base plate
- ④ Fastener guide
- ⑤ Piston
- ⑥ Spring clip
- ⑦ Catch
- ⑧ Annular spring
- ⑨ Ball
- ⑩ Additional base plate

1 Safety instructions

1.1 Basic information concerning safety

In addition to the information relevant to safety given in each of the sections of these operating instructions, the following points must be strictly observed at all times.

1.1.1 Using cartridges

Use only Hilti cartridges or cartridges of equivalent quality.

Use of cartridges of inferior quality in Hilti tools may lead to a build-up of unburned powder, which may explode and cause severe injuries to operators and bystanders. Cartridges must fulfill one of the following minimum requirements:

- a) **The applicable manufacturer must be able to verify successful testing in accordance with the EU standard EN 16264 or**
- b) **The cartridges must bear the CE conformity mark (mandatory in the EU as of July 2013).**

NOTE

All Hilti cartridges for powder-actuated tools have been tested successfully in accordance with EN 16264. The tests defined in the EN 16264 standard are system tests

carried out by the certification authority using specific combinations of cartridges and tools. The tool designation, the name of the certification authority and the system test number are printed on the cartridge packaging.

Please refer to the packaging example at: www.hilti.com/dx-cartridges

1.1.2 Requirements to be met by users

- a) **The tool is intended for professional use.**
- b) **The tool may be operated, serviced and repaired only by authorized, trained personnel. This personnel must be informed of any special hazards that may be encountered.**

1.1.3 Personal safety

- a) **Stay alert, watch what you are doing and use common sense when operating a direct fastening tool. Don't use the tool when you are tired or under the influence of drugs, alcohol or medication. Stop using the tool if you experience pain or do not feel well. A moment of inattention while operating the tool may result in serious personal injury.**

- b) **Avoid unfavorable body positions. Make sure you work from a safe stance and stay in balance at all times.**
- c) **Wear non-skid shoes.**
- d) **Never point the tool toward yourself or other persons.**
- e) **Never press the nosepiece of the tool against your hand or against any other part of your body (or other person's hand or part of their body).**
- f) **Keep other persons, especially children, away from the area in which the work is being carried out.**
- g) **Keep the arms slightly bent while operating the tool (do not straighten the arms).**
- h) **Observe the information printed in the operating instructions concerning operation, care and maintenance.**

1.1.4 Use and care of powder-actuated fastening tools

- a) **Use the right tool for the job. Do not use the tool for purposes for which it was not intended. Use it only as directed and when in faultless condition.**
- b) **Never leave a loaded tool unattended.**
- c) **Store unused cartridges and tools currently not in use in a dry place where they are not exposed to high temperatures.**
- d) **Transport and store the tool in a toolbox that can be secured to prevent unauthorized use.**
- e) **Always unload the tool (remove cartridges and fasteners) before cleaning, before maintenance, before work breaks and before storing the tool.**
- f) **When not in use, tools must be unloaded and stored in a dry place, locked up or out of reach of children.**
- g) **Check the tool and its accessories for any damage. Guards, safety devices and any slightly worn parts must be checked carefully to ensure that they function faultlessly and as intended. Check that moving parts function correctly without sticking and that no parts are damaged. All parts must be fitted correctly and fulfill all conditions necessary for correct operation of the tool. Damaged guards, safety devices and other parts must be repaired or replaced properly at a Hilti service center unless otherwise indicated in the operating instructions.**
- h) **Pull the trigger only when the tool is fully pressed against the working surface at right angles.**
- i) **Always hold the tool securely and at right angles to the working surface when driving in fasteners. This will help to prevent fasteners being deflected by the working surface.**
- j) **Never redrive a fastener. This may cause the fastener to break and the tool may jam.**
- k) **Never drive fasteners into existing holes unless this is recommended by Hilti.**
- l) **Always observe the application guidelines.**
- m) **Use the spall guard when the application permits.**
- n) **Never pull the fastener guide or the fastener back by hand as this could make the tool ready to fire.**

This could cause a fastener or the piston to be driven into a part of the body.

1.1.5 Work area safety

- a) **Ensure that the workplace is well lit.**
- b) **Operate the tool only in well-ventilated working areas.**
- c) **Do not attempt to drive fasteners into unsuitable materials:** Materials that are too hard, e.g. welded steel and cast iron. Materials that are too soft, e.g. wood and drywall panel (gypsum board). Materials that are too brittle, e.g. glass and ceramic tiles. Driving a fastener into these materials may cause the fastener to break, shatter or to be driven right through.
- d) **Never attempt to drive fasteners into materials such as glass, marble, plastic, bronze, brass, copper, rock, insulation material, hollow brick, ceramic brick, thin sheet metal (< 4 mm), cast iron or cellular concrete.**
- e) **Before driving fasteners, check that no one is present immediately behind or below the working surface.**
- f) **Keep the workplace tidy. Objects which could cause injury should be removed from the working area.** Untidiness at the workplace can lead to accidents.
- g) **Keep the grips dry, clean and free from oil and grease.**
- h) **Do not use the tool where there is a risk of fire or explosion unless it has been specially approved for use under these conditions.**
- i) **Concealed electric cables or gas and water pipes present a serious hazard if damaged while you are working. Accordingly, check the area in which you are working beforehand (e.g. using a metal detector). External metal parts of the tool or machine may become live, for example, when an electric cable is damaged accidentally.**
- j) **Use the fasteners only within the recommended temperature range. Always observe the information given in the operating instructions.** Plastic parts can break and splinter at low temperatures.

1.1.6 Mechanical safety precautions

- a) **Use only fasteners of a type approved for use with the tool.**
- b) **Do not tamper with or modify the tool or parts of it, especially the piston.**

1.1.7 Thermal safety precautions

- a) **If the tool has overheated, allow it to cool down. Do not exceed the recommended fastener driving rate.**
- b) **Do not dismantle the tool while it is hot. Allow the tool to cool down.**
- c) **The tool must be allowed to cool down if the plastic cartridge strip begins to melt.**

1.1.8 Danger of explosion



- a) Use only cartridges of a type approved for use with the tool.
- b) Remove the cartridge strip from the tool carefully.

- c) Never attempt to pry a cartridge from the magazine strip or tool. Never attempt to open a cartridge.
- d) Store unused cartridges in a secure place where they are not exposed to dampness or excessively high temperatures.

1.1.9 Personal protective equipment

The user and any other persons in the vicinity must wear suitable eye protection, a hard hat and ear protection while the tool is in use or when remedying a problem with the tool.

en

2 General information

2.1 Safety notices and their meaning

DANGER

Draws attention to imminent danger that will lead to serious bodily injury or fatality.

WARNING

Draws attention to a potentially dangerous situation that could lead to serious personal injury or fatality.

CAUTION

Draws attention to a potentially dangerous situation that could lead to slight personal injury or damage to the equipment or other property.

NOTE

Draws attention to an instruction or other useful information.

2.2 Explanation of the pictograms and other information

Warning signs



General warning



Warning: explosive substances



Warning: hot surface

Obligation signs



Wear protective glasses



Wear a hard hat



Wear ear protection

Symbols



Read the operating instructions before use

Location of identification data on the tool

The type designation and serial number can be found on the type identification plate on the tool. Make a note of this data in your operating instructions and always refer to it when making an enquiry to your Hilti representative or service department.

Type: _____

Generation: 01 _____

Serial no.: _____

3 Description

3.1 Use of the product as directed

The tool is designed for professional use in fastening applications where nails, threaded studs and composite fasteners are driven into concrete, steel and sand-lime block masonry.

The tool is for hand-held use only.

Modification of the tool is not permitted.

The tool may not be used in an explosive or flammable atmosphere unless it has been approved for use under these conditions.

To reduce the risk of injury use only genuine Hilti fasteners, cartridges, accessories and spare parts or those of equivalent quality.

Observe the information printed in the operating instructions concerning operation, care and maintenance.

The tool and its ancillary equipment may present hazards when used incorrectly by untrained personnel or when used not as directed.

The tool may be operated, serviced and repaired only by trained personnel. This personnel must be informed of any special hazards that may be encountered.

As with all powder-actuated fastening tools, the tool, cartridges and fasteners form a technical unit. This means that trouble-free fastening with this system can be assured only if the Hilti fasteners and cartridges specially manufactured for it, or products of equivalent quality, are used. The fastening and application recommendations given by Hilti apply only when these conditions are observed.

3.2 Range of fasteners available for various applications

Fasteners

Ordering designation	Application
X-U	High-strength nail for fastening on high-strength steel and concrete in a wide range of applications
X-C	Standard nail for fastening on concrete
X-S	Standard nail for efficient fastening on steel
X-CT	Easily removable nail for fastening formwork temporarily on concrete
X-CR	Stainless steel nail for fastening in damp or corrosive surroundings
X-CF	Special fastener for timber structures on concrete
X-FS	Fastener for positioning formwork
X-SW	Flexible washer fastener for fastening plastic sheeting and thin insulating materials to concrete and steel
X-HS / X-HS-W	Suspension system with threaded connection
X-CC	Fastening clip for wire hangers
X-(D)FB / X-EMTC	Metal conduit clip for fastening electrical conduits or insulated pipes (hot or cold) in water supply and heating installations
X-EKB	Cable clasp for fastening electric cables flat on ceilings and walls
X-ECH	Bunched cable holder for fastening cables on ceilings and walls
X-ET	Fastener for plastic (PVC) electric cable trunking
X-(E)M/W/6/8	Threaded stud for fastenings on concrete and steel

Cartridges

Cartridge type	Color	Power level
6.8/11 M green	green	light
6.8/11 M yellow	yellow	medium
6.8/11 M red	red	heavy

en

4 Accessories, consumables

NOTE

For information about further accessories and fasteners for use with the tool, please contact your local Hilti representative.

Accessories and cleaning set

Designation
Cleaning set
Hilti spray
Spare parts pack
Operating instructions
Additional base plate

Standard accessories

Designation
Piston
Base plate
Piston guide
Fastener guide
Spring clip
Catch
Annular spring

5 Technical data

Right of technical changes reserved.

Tool	DX 2
Weight	2.4 kg
Dimensions (L x W x H)	345 mm x 50 mm x 157 mm
Maximum fastener length	62 mm (2½")
Cartridges	6.8/11 M (27 cal. short) green, yellow, red
Contact movement	16 mm (0.63")
Contact pressure	160 N
Ambient operating temperature range	-15... +50°C
Recommended maximum fastening rate	450/h

6 Before use



NOTE

Read the operating instructions before you operate the tool for the first time.

6.1 Checking the tool 2

WARNING

Do not operate the tool when parts are damaged or when the controls do not function correctly. If necessary, have the tool repaired at an authorized Hilti service center.

Check that no cartridge strip is loaded in the tool. If there is a cartridge strip in the tool, pull it up out of the tool by hand from above.

Check all external parts of the tool for damage and check that all controls operate faultlessly.
Check the piston and spring clip for wear and ensure that the parts have been fitted correctly.

7 Guidelines

7.1 Fastening guidelines

These guidelines must be observed at all times.

NOTE

For detailed information, please ask your local Hilti sales and service office for a copy of the applicable technical guidelines or national technical regulations.

7.1.1 Minimum distances and spacing

Minimum distances and spacing when fastening to steel

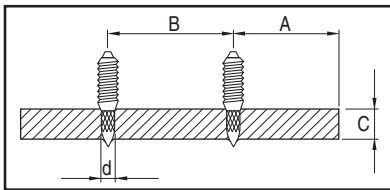

A	min. edge distance = 15 mm ($\frac{5}{8}$ "
B	min. spacing = 20 mm ($\frac{3}{4}$ "
C	min. base material thickness = 3 mm ($\frac{1}{8}$ "

Minimum distances and spacing when fastening to concrete

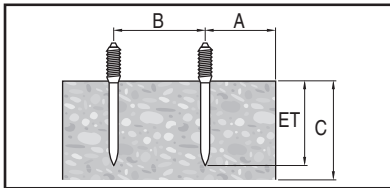

A	min. edge distance = 70 mm ($2\frac{3}{4}$ "
B	min. spacing = 80 mm ($3\frac{1}{8}$ "
C	min. base material thickness = 100 mm (4")

7.1.2 Depth of penetration

NOTE

Examples and specific information can be found in the Hilti Fastening Technology Manual.

Nail lengths for steel

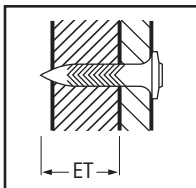

ET	Depth of penetration: 12 ± 2 mm ($\frac{1}{2}$ " \pm $\frac{1}{16}$ "
----	--

en

Nail lengths for concrete

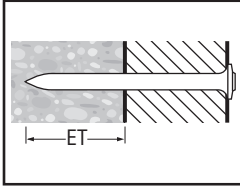

ET Depth of penetration: 22 mm (max. 27 mm) (7/8" (max. 1"))

en

8 Operation

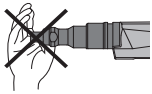

WARNING

The material can be made ready to fire by pressing the nosepiece against a part of the body (e.g. a hand). When the tool is ready to fire, fasteners or the piston could be driven inadvertently into parts of the body. **Never press the tool against parts of the body.**

WARNING

The material may splinter or fragments of the magazine strip may fly off when the fastener is driven. **The user of the tool and other persons in the immediate vicinity must wear suitable eye protection and a hard hat.** Splintering material presents a risk of injury to the eyes and body.

CAUTION

The fastener driving action is initiated by ignition of a propellant charge. **The user of the tool and other persons in the immediate vicinity must wear ear protectors.** Exposure to noise can cause hearing loss.

WARNING

Never redrive a fastener. This may cause the fastener to break and the tool may jam.

WARNING

Never drive fasteners into existing holes unless this is recommended by Hilti (e.g. DX-Kwik).

CAUTION

If the tool has overheated, allow it to cool down. Do not exceed the recommended fastener driving rate.

8.1 Procedure if a cartridge fails to fire

If a cartridge fails to fire or misfires, always proceed as follows:

Keep the nose of the tool pressed at right angles against the working surface for 30 seconds.

If the cartridge still fails to fire, withdraw the tool from the working surface, taking care to avoid pointing it toward your body or toward bystanders.

Load the next cartridge on the strip by cycling the tool. Use up the remaining cartridges on the strip and remove the used cartridge strip from the tool. The (partly) used cartridge strip must then be disposed of appropriately to prevent further use or misuse of any unfired cartridges.

8.2 Loading the tool 3

1. Push the nail, head first, into the nose of the tool from the front until it is held in place in the tool by the washer on the nail.
2. Push the cartridge strip, narrow end first, into the grip of the tool from below until the full length of the cartridge strip is inside the grip.
3. If you wish to use a partly-used cartridge strip, pull the strip upwards by hand out of the tool slightly until the first unused cartridge is in place in the cartridge chamber.

8.3 Setting the power level

1. Select the cartridge power level according to the application to be carried out.
2. If you cannot estimate this on the basis of previous experience, always begin with the lowest power. Select the lowest power level according to the color code.
3. Drive a nail.
If the nail is not driven deeply enough, use a more powerful cartridge if necessary or, alternatively, use a shorter nail.

8.4 Driving a fastener 4

WARNING

Always observe the safety rules listed in the operating instructions.

1. Press the tool against the working surface at right angles.
2. Drive the fastener by pulling the trigger.

8.5 Cycling the tool 5

CAUTION

Do not use a swinging movement to cycle the tool (piston return and cartridge transport). The swinging

movement may lead to injury or cause damage to the tool.

NOTE

If the cycling action (i.e. pulling out, pushing back in) is stiff, this indicates that the tool needs to be cleaned. Service the tool! (see section 9.3).

1. After driving a fastener, grip the collar at the nose of the tool between the thumb and forefinger.
2. Pull the nose unit forward in the main axis of the tool as far as it will go.

3. Then pull the fastener guide all the way back to its original position.

This movement brings the piston back to its starting position and advances the cartridge strip to the next cartridge.

The tool is then ready to drive the next fastener.

8.6 Unloading the tool 6

Check that there is no cartridge strip or fastener in the tool.

If there is a cartridge strip or fastener in the tool, pull the cartridge strip up out of the tool by hand from above and remove the fastener from the fastener guide.

en

9 Care and maintenance



CAUTION

When this type of tool is used under normal operating conditions, dirt and residues build up inside the tool and functionally relevant parts are also subject to wear. **Regular inspections and maintenance are thus essential in order to ensure reliable operation. We recommend that the tool is cleaned and the condition of the piston checked at least daily when the tool is subjected to intensive use, and at the latest after driving 3,000 fasteners.**

WARNING

All cartridges must be removed from the tool. Check to ensure that no fastener is present in the fastener guide before carrying out maintenance or repairs.

CAUTION

The tool may get hot during use. You could burn your hands. **Wear protective gloves when carrying out care and maintenance. Allow the tool to cool down.**

9.1 Care of the tool

Clean the outside of the tool at regular intervals with a slightly damp cloth.

WARNING

Do not clean with a spray or pressure washer. Do not permit foreign objects to enter the interior of the tool.

9.2 Maintenance

Check all external parts of the tool for damage at regular intervals and check that all controls operate faultlessly. Do not operate the tool if parts are damaged or when the controls do not function faultlessly. If necessary, the tool should be repaired by Hilti Service.

Use the tool only with the recommended cartridges and power settings. Use of the wrong cartridges or use of excessively high power settings may lead to premature failure of parts of the tool.

CAUTION

Dirt and residues in DX tools contain substances that may be hazardous to your health. **Do not inhale dust / or dirt from cleaning. Keep the dust or dirt away from foodstuffs. Wash your hands after cleaning the tool. Never use grease for the maintenance/lubrication of parts of the tool. This may lead to malfunctions. Use only Hilti lubricant spray or a product of comparable quality.**

9.3 Servicing the tool

Service the tool if fastener driving power is found to be inconsistent, if cartridges misfire or if parts of the tool no longer move or operate smoothly and easily. In other words, the required contact pressure increases, trigger resistance increases, the cartridge magazine strip can only be removed with a degree of difficulty or the cycling action becomes stiff.

9.3.1 Disassembling the tool 7

CAUTION

When removing the spring clip from the base plate, the spring clip may jump off the base plate very suddenly. **Take care to avoid injury to yourself or other persons. Hold the base plate so that the spring clip, if it jumps off, tends to jump towards the floor.**

1. Lift the annular ring with a small prybar or a nail and turn.
2. Pull the catch back and remove it.
3. Pull out the insert.
4. Remove the spring clip. Use a suitable tool for this purpose (e.g. small prybar or nail).
5. Pull the base plate, complete with the fastener guide, off the piston guide.
6. Pull the piston out of the piston guide.
7. Allow the fastener guide to slide out of the base plate toward the rear.

NOTE If the parts of the tool tend to stick due to carbon build-up, use the piston to push the fastener guide out of the base plate from the front.

9.3.2 Checking the piston for wear

NOTE

Never use a worn or damaged piston and do not tamper with or modify the piston.

Replace the piston if:

- the piston is broken
- the piston is badly worn or chipped (e.g. a 90° segment broken away).
- the piston ring is cracked or missing.
- the piston is bent (check by rolling the piston on a smooth, flat surface).

9.3.3 Checking the fastener guide for wear

Replace the fastener guide if the tubular section is damaged (e.g. bent, widened, cracked or broken).

9.3.4 Checking the spring clip for wear

Replace the spring clip if it is badly worn, bent or widened.

9.3.5 Cleaning 8 9 10 11

Clean the tool at least once a week or, respectively, immediately after each period of heavy use (after driving approx. 3,000 nails).

Use the appropriate brushes to clean the individual parts:

1. Clean the fastener guide and base plate, inside and out.
2. Clean the piston and piston rings until the parts move freely.
3. Clean the piston guide, inside and out.
4. Clean the inside of the housing.

9.3.6 Lubrication

Spray the cleaned parts lightly with the Hilti lubricant spray supplied. Use only Hilti lubricant spray or a product of comparable quality.

9.3.7 Assembling the tool 12

NOTE

Handle the small parts carefully. They could get lost.

1. Fit the fastener guide into the base plate.
2. Slide the piston into the piston guide as far as it will go.
3. Fit the base plate with the fastener guide onto the piston guide.

NOTE The slots in the base plate and piston guide must be in alignment with each other.

4. Press the spring clip into the recess.
5. Guide the assembly into the tool.

NOTE The slot in the piston and fastener guide must be in alignment with the opening for the catch.

6. Press the catch into the opening and turn the annular ring back over the catch.

NOTE The catch can be removed when in the swiveled-out position and subsequently reinserted.

9.3.8 Checking

After carrying out care and maintenance, check that all protective and safety devices are fitted and that they function faultlessly.

NOTE

The tool can be checked, as follows, to determine whether it is ready to fire: Press the nose of the unloaded tool (i.e. no cartridges or fastener in the tool) firmly against a hard surface and pull the trigger. A clearly heard click from the trigger mechanism indicates that the tool was ready to fire.

10 Troubleshooting

WARNING

The tool must be unloaded before taking any steps to remedy faults.

Fault	Possible cause	Remedy
Higher force required to cycle the tool.	Build-up of combustion residues.	Service the tool See section: 9.3 Servicing the tool
Higher force required to press the tool against the surface.	Build-up of combustion residues.	Service the tool See section: 9.3 Servicing the tool
Trigger resistance increases.	Build-up of combustion residues.	Service the tool See section: 9.3 Servicing the tool
The cartridge strip is difficult to remove.	Build-up of combustion residues.	Service the tool See section: 9.3 Servicing the tool

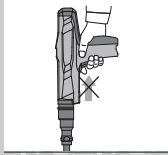
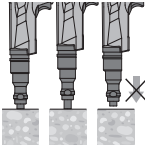
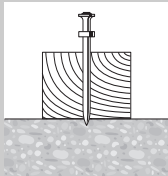
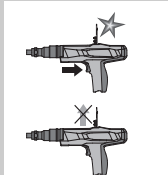
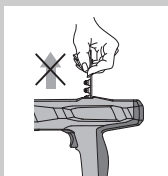
Fault	Possible cause	Remedy
<p>The tool cannot be fired.</p> 	<p>The tool is not cycled. The cartridge has already been fired.</p> <hr/> <p>The tool was not pressed fully against the working surface.</p>	<p>See section: 8.5 Cycling the tool 5 Transport the used cartridge by cycling the tool or pull the cartridge strip through manually to the next position.</p> <hr/> <p>Press the tool fully against the working surface. Service the tool See section: 9.3 Servicing the tool</p>
<p>Tool jams.</p> 	<p>The tool is badly fouled with dirt and residues.</p> <hr/> <p>The piston is damaged.</p> <hr/> <p>The tool is damaged.</p>	<p>Clean the tool. See section: 9.3 Servicing the tool</p> <hr/> <p>Check the piston and replace it if necessary. See section: 9.3.2 Checking the piston for wear</p> <hr/> <p>If the problem persists, contact your local Hilti Center.</p>
<p>Misfire: Less than normal sound. The fastener is only partly driven into the base material.</p> 	<p>The piston was in the wrong position.</p> <hr/> <p>Bad cartridges.</p>	<p>Remove the cartridge strip and cycle the tool. See section: 8.5 Cycling the tool 5</p> <hr/> <p>Change the cartridge strip (use a different / dry package if necessary). If the problem persists, service the tool. See section: 9.3 Servicing the tool</p>
<p>The cartridge strip doesn't advance.</p> 	<p>The cartridge strip is damaged.</p> <hr/> <p>The tool is badly fouled with dirt and residues.</p> <hr/> <p>The tool is damaged.</p>	<p>Change the cartridge strip.</p> <hr/> <p>Clean the tool. See section: 9.3 Servicing the tool</p> <hr/> <p>If the problem persists, contact your local Hilti Center.</p>
<p>The cartridge strip cannot be removed.</p> 	<p>The tool has overheated.</p>	<p>Allow the tool to cool down. Subsequently, carefully remove the cartridge strip from the tool. WARNING Never attempt to pry a cartridge from the magazine strip or tool. If the problem persists, contact your local Hilti Center.</p>

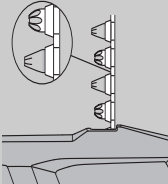
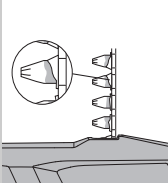
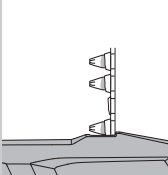
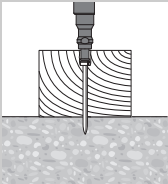
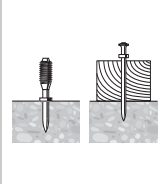
Fault	Possible cause	Remedy
<p>A cartridge doesn't fire.</p> 	<p>Bad cartridge.</p> <hr/> <p>The tool needs to be cleaned.</p>	<p>Pull the cartridge strip through to the next cartridge.</p> <hr/> <p>Service the tool</p> <p>WARNING</p> <p>Check that the correct cartridges are used and that they are in faultless condition.</p> <p>See section: 9.3 Servicing the tool</p> <p>If the tool cannot be disassembled, contact your local Hilti Center.</p>
<p>The cartridge strip melts.</p> 	<p>The tool is pressed against the working surface for too long before firing.</p> <hr/> <p>The fastener driving rate is too high.</p>	<p>Fire the tool sooner after pressing it against the working surface.</p> <p>Remove the cartridge strip.</p> <hr/> <p>Stop using the tool immediately.</p> <p>Remove the cartridge strip and allow the tool to cool.</p> <p>WARNING</p> <p>Never attempt to pry a cartridge from the magazine strip or tool.</p> <p>Clean the tool and remove any loose cartridges.</p> <p>If the tool cannot be disassembled contact your local Hilti Center.</p>
<p>A cartridge detaches itself from the cartridge strip.</p> 	<p>The fastener driving rate is too high.</p>	<p>Stop using the tool immediately.</p> <p>Remove the cartridge strip and allow the tool to cool.</p> <p>WARNING</p> <p>Never attempt to pry a cartridge from the magazine strip or tool.</p> <p>Clean the tool and remove any loose cartridges.</p> <p>If the tool cannot be disassembled contact your local Hilti Center.</p>
<p>The piston gets stuck in the base material / fastener is driven too deeply.</p> 	<p>The fastener is too short.</p> <hr/> <p>The fastener has no washer.</p> <hr/> <p>Driving power is too high.</p>	<p>Use a longer fastener.</p> <hr/> <p>Use a fastener with washer for applications on wood.</p> <hr/> <p>Use a less powerful cartridge.</p>
<p>The fastener is not driven deeply enough.</p> 	<p>The fastener is too long.</p> <hr/> <p>Driving power is too low.</p>	<p>Use a shorter fastener.</p> <p>NOTE</p> <p>Observe the min. fastener driving depth requirements. Obtain a copy of the Fastening Technology Manual from your local Hilti Center.</p> <hr/> <p>Use a more powerful cartridge.</p>

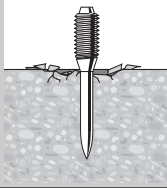
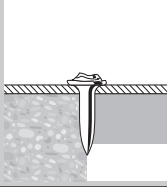
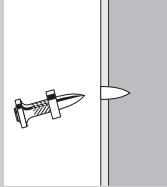
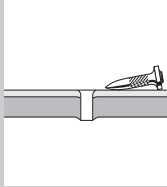
Fault	Possible cause	Remedy
<p>The nail bends.</p> 	<p>Hard surface (steel, concrete)</p> <hr/> <p>Hard and/or large aggregates in the concrete.</p> <hr/> <p>A rebar is located just below the concrete surface.</p>	<p>Use a more powerful cartridge.</p> <hr/> <p>Use a more powerful cartridge. Use the DX 460 with DX-Kwik (pre-drilling).</p> <hr/> <p>Use a shorter nail. Use a nail with a higher application limit. Use the DX 460 with DX-Kwik (pre-drilling). Drive the fastener at a different position.</p>
<p>Concrete spalling.</p> 	<p>Hard/old concrete.</p> <hr/> <p>Hard and/or large aggregates in the concrete.</p>	<p>Use a shorter nail.</p> <hr/> <p>Use a more powerful cartridge. Use the DX 460 with DX-Kwik (pre-drilling).</p>
<p>Damaged nail head.</p> 	<p>Driving power is too high.</p> <hr/> <p>Application limit exceeded (very hard material).</p> <hr/> <p>The piston is damaged.</p>	<p>Use a less powerful cartridge.</p> <hr/> <p>Use a nail with a higher application limit.</p> <hr/> <p>Change the piston.</p>
<p>The nail doesn't penetrate deeply enough.</p> 	<p>Driving power is too low.</p> <hr/> <p>Application limit exceeded (very hard material).</p> <hr/> <p>The system is unsuitable.</p> <hr/> <p>The piston was in the wrong position.</p>	<p>Use a more powerful cartridge.</p> <hr/> <p>Use a nail with a higher application limit.</p> <hr/> <p>Use a more powerful system, e.g. DX 460.</p> <hr/> <p>Remove the cartridge strip and cycle the tool. See section: 8.5 Cycling the tool 5</p>
<p>The nail doesn't hold in the base material.</p> 	<p>Thin steel base material</p>	<p>Use a different cartridge. Use a nail suitable for thin steel base material. Base material < 3 mm is not suitable for DX.</p>

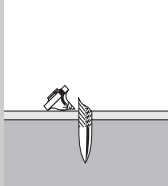
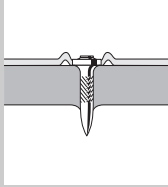
Fault	Possible cause	Remedy
Nail breakage.	Driving power is too low.	Use a more powerful cartridge.
	Application limit exceeded (very hard material).	Use a shorter nail. Use a nail with a higher application limit.
	The system is unsuitable.	Use a more powerful system, e.g. DX 460.
	The head of the nail punches through the material fastened (sheet metal).	Driving power is too high.
		

11 Disposal



Most of the materials from which Hilti tools or appliances are manufactured can be recycled. The materials must be correctly separated before they can be recycled. In many countries, Hilti has already made arrangements for taking back old tools and appliances for recycling. Ask Hilti customer service or your Hilti representative for further information.

12 Manufacturer's warranty - tools

Please contact your local Hilti representative if you have questions about the warranty conditions.

13 EC declaration of conformity (original)

Designation:	Powder-actuated fastening tool
Type:	DX 2
Generation:	01
Year of design:	2014

We declare, on our sole responsibility, that this product complies with the following directives and standards: 2006/42/EC, 2011/65/EU.

Hilti Corporation, Feldkircherstrasse 100,
FL-9494 Schaan



Norbert Wohlwend
Head of Quality & Processes Management
BU Direct Fastening
02/2014



Lars Taenzler
Head of BU Direct Fastening
BU Direct Fastening
02/2014

en

Technical documentation filed at:

Hilti Entwicklungsgesellschaft mbH
Zulassung Elektrowerkzeuge
Hiltistrasse 6
86916 Kaufering
Deutschland

14 Confirmation of CIP testing

The following applies to C.I.P. member states outside the EU and EFTA judicial area: The Hilti DX 2 has been system and type tested. As a result, the tool bears the rectangular PTB approval mark showing approval number S 830. Hilti

thus guarantees compliance with the approved type. Unacceptable defects or deficiencies, etc. determined during use of the tool must be reported to the person responsible at the approval authority (PTB) and to the Office of the Permanent International Commission (C.I.P.).

15 Health and safety of the operator

15.1 Noise information

Powder-actuated fastening tool

Type	DX 2
Model	Serial
Caliber	6.8/11
Application	Fastening 20 mm laminated wood to concrete (C40) with the X-U47 P8

Declared measured values of noise characteristics according to 2006/42/EC Machinery Directive in conjunction with DIN EN 15895

Noise (power) level, $L_{WA, 1S}^1$	101 dB (A)
Emission noise-pressure level in the work station, $L_{pA, 1s}^2$	104 dB (A)
Peak sound pressure emission level, $L_{pC, peak}^3$	139 dB (C)

¹ ± 2 dB (A)

² ± 2 dB (A)

³ ± 2 dB (C)

Operation and set-up conditions: Set-up and operation of the powder-actuated fastening tool in accordance with E DIN EN 15895-1 in the semi-anechoic test room of Müller-BBM GmbH. The ambient conditions in the test room conform to DIN EN ISO 3745.

Testing procedure: Enveloping surface method in anechoic room on reflective surface area in accordance with E DIN EN 15895, DIN EN ISO 3745 and DIN EN ISO 11201.

NOTE The noise emissions measured and the associated measurement uncertainty represent the upper limit for the noise values to be expected during the measurements.
Variations in operating conditions may cause deviations from these emission values.

15.2 Vibration

Total vibration in accordance with 2006/42/EC does not exceed 2.5 m/s².

Further information about user health and safety can be found at www.hilti.com/hse.



Hilti Corporation

LI-9494 Schaan

Tel.: +423/234 21 11

Fax: +423/234 29 65

www.hilti.com

Hilti = registered trademark of Hilti Corp., Schaan
Pos. 2 | 20150226



2083450