

HILTI

PP 10/11

Bedienungsanleitung	de
Operating instructions	en
Mode d'emploi	fr
Istruzioni d'uso	it
Manual de instrucciones	es
Manual de instruções	pt
Gebruiksaanwijzing	nl
Οδηγίες χρήσεως	el
Instrukcja obsługi	pl
Návod k obsluze	cs
Návod na obsluhu	sk
Kullanma Talimatı	tr
사용설명서	ko

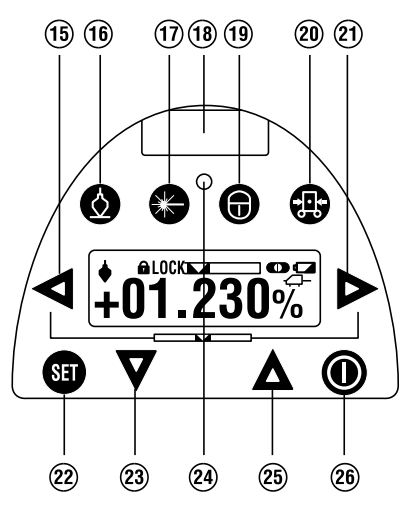

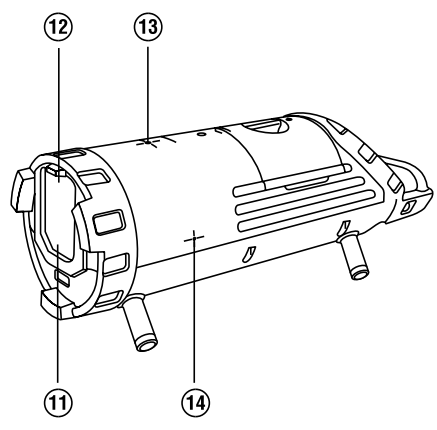
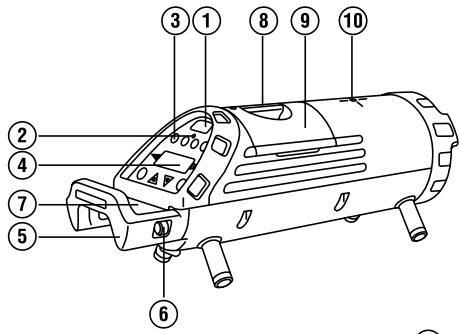

2

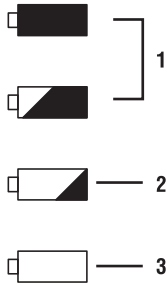

3

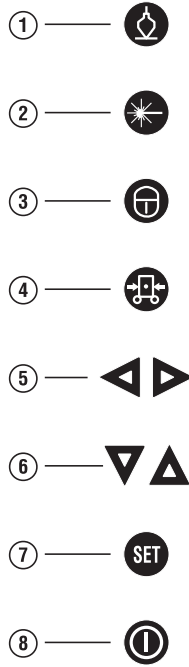

4

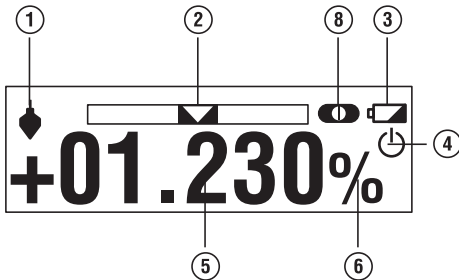
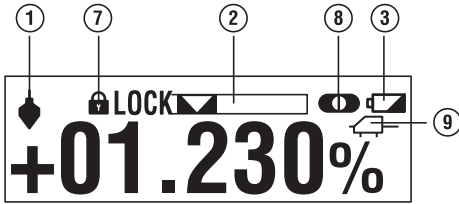

5

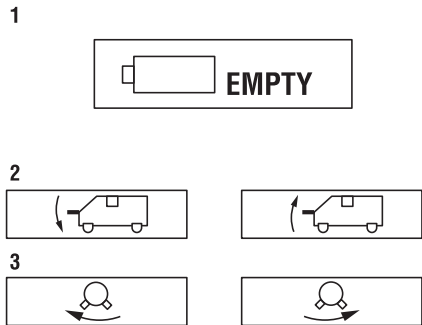

6

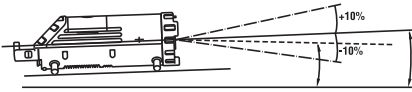

- 1
- 2
- 3
- 4
- 5
- 6
- 7
- 8

7

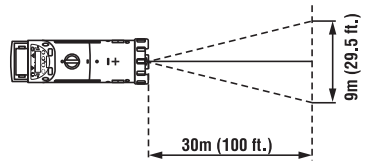

- 1
- 2
- 3

8

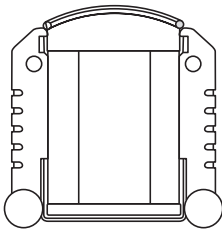

- 1
- 2
- 3
- 3
- 4
- 5

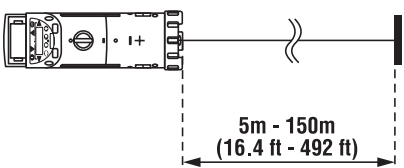

9

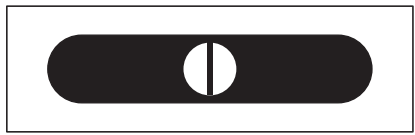

ORIGINAL OPERATING INSTRUCTIONS

PP 10 / 11 pipe laser

It is essential that the operating instructions are read before the tool is operated for the first time.

Always keep these operating instructions together with the tool.

Ensure that the operating instructions are with the tool when it is given to other persons.

Contents	Page
1 General information	13
2 Description	15
3 Accessories	15
4 Technical data	16
5 Safety instructions	16
6 Before use	17
7 Operation	18
8 Care and maintenance	22
9 Troubleshooting	22
10 Disposal	22
11 Manufacturer's warranty - tools	23
12 EC declaration of conformity (original)	23

I These numbers refer to the illustrations. You can find the illustrations at the beginning of the operating instructions.

In these operating instructions, the designation "the tool" always refers to the PR 10 / 11 pipe laser.

Component parts **I**

PP 10 / 11 pipe laser

- ① Remote control signal receiving window
- ② Warning / standby LED
- ③ Control panel
- ④ Display
- ⑤ Grip
- ⑥ Grip mount
- ⑦ PPA 84 cable connector
- ⑧ Battery compartment cover lock
- ⑨ PPA 82 battery incl. mains adaptor
- ⑩ Plumb spot

PP 10 / 11 pipe laser

- ⑪ Laser exit window
- ⑫ Remote control signal receiving window
- ⑬ Plumb spot
- ⑭ Pivot point mark

Control panel

- ⑮ Direction control / auto-centering button
- ⑯ Plumb spot button
- ⑰ Laser beam mode button
- ⑱ Remote control signal receiving window
- ⑲ "Lock" button
- ⑳ Target plate auto-centering button
- ㉑ Direction control / auto-centering button
- ㉒ SET button
- ㉓ Laser beam up / down, value-entry button
- ㉔ Warning / standby LED
- ㉕ Laser beam up / down, value-entry button
- ㉖ ON / OFF button

1 General information

1.1 Safety notices and their meaning

DANGER

Draws attention to imminent danger that will lead to serious bodily injury or fatality.

WARNING

Draws attention to a potentially dangerous situation that could lead to serious personal injury or fatality.

CAUTION

Draws attention to a potentially dangerous situation that could lead to personal injury or damage to the equipment or other property.

NOTE

Draws attention to an instruction or other useful information.

1.2 Explanation of the pictograms and other information

Warning signs



General warning

en

Symbols



Read the operating instructions before use.



Return materials for recycling

On the tool



Do not stare into the beam.
Laser warning plates for the USA in accordance with CFR 21 § 1040 (FDA).

On the tool



Do not stare into the beam.
Laser warning plates for the USA in accordance with CFR 21 § 1040 (FDA).

On the tool



Laser warning plate in accordance with IEC825 / EN60825-1:2003

Type identification plate

**AVOID EXPOSURE
LASER LIGHT IS EMITTED
FROM THIS APERTURE**



PP 10

Made in Japan
Hilti® registered trademark of the Hilti Corporation, Schaan, Liechtenstein

DANGER

LASER RADIATION - AVOID DIRECT EYE EXPOSURE

620-690nm < 5mW max.
CLASS IIIa LASER PRODUCT

EN 60825-1:2003
This Laser Product
complies with 21CFR
1040 as applicable

Power: 6.0V=nom./250 mA

Item No.: 319781
Date ..:

319789

PP 10

Type identification plate

**AVOID EXPOSURE
LASER LIGHT IS EMITTED
FROM THIS APERTURE**



PP 11

Made in Japan
Hilti® registered trademark of the Hilti Corporation, Schaan, Liechtenstein

DANGER

LASER RADIATION - AVOID DIRECT EYE EXPOSURE

520-550nm < 5mW max.
CLASS IIIa LASER PRODUCT

EN 60825-1:2003
This Laser Product
complies with 21CFR
1040 as applicable

Power: 6.0V=nom./250 mA

Item No.: 319791
Date ..:

PP 11

Location of identification data on the tool

The type designation and serial number can be found on the type identification plate on the tool. Make a note of this data in your operating instructions and always refer to it when making an enquiry to your Hilti representative or service department.

Type: _____

Serial no.: _____

2 Description

2.1 Use of the product as directed

The tool is designed to be used for determining, transferring or checking alignment in the horizontal and inclined planes, e.g.: transferring heights and in pipe laying work. Hilti supplies various accessories which allow the tool to be used with maximum efficiency.

2.2 PP 10/11 pipe laser

The PP 10/11 is a pipe laser featuring a visible laser beam (spot) that can be used for alignment in the horizontal or inclined planes.

2.3 Features

A single person working with the tool can set out any desired inclination (within the -15% to +40% range) with great accuracy. The tool levels itself automatically when set up within $\pm 10\%$ of the horizontal plane.

2.4 Automatic cut-out

The laser beam and the LED on the control panel blink if the tool is set up outside its self-leveling range. The direction in which the tool requires to be tilted is also shown in the display.

2.5 PPA 82 battery

Battery performance drops at low temperatures.

DANGER

Batteries should be stored at room temperature.

DANGER

Never store the battery where it is exposed to the heat of the sun, on a radiator or behind glass, e.g. at a window.

2.6 Automatic charging cut-out

The charging operation is stopped automatically to protect the battery when the temperature exceeds the specified charging temperature range.

NOTE

Charge the battery every 3 to 4 months. Store the battery at a maximum temperature of 30°C (86°F). Allowing the battery to become fully discharged may have a negative effect on its future performance. Charging may take less than 9 hours if the battery was not previously fully discharged.

2.7 Use of various power sources

Three different power sources may be used: the standard PPA 82 battery supplied or the PPA 83 battery holder or PPA 84 external 12V cable which are available as accessories.

2.8 Items supplied

- 1 PP 10 or 11 pipe laser (depending on version purchased)
- 1 PPA 20 remote control unit
- 1 Target plate, short
- 1 Target plate, long
- 1 PPA 74 target plate holder
- 1 PPA 81 charging adaptor
- 1 PPA 82 battery incl. mains adaptor
- 1 Set of 4 screw feet, 150 mm
- 1 Set of 4 screw feet, 200 mm
- 1 Set of 4 screw feet, 250 mm
- 1 Set of 4 screw feet, 300 mm
- 1 PPA 30 centering screw
- 1 PP 10 / 11 operating instructions
- 1 PPA 20 operating instructions
- 4 Batteries (size AAA cells)
- 1 Manufacturer's certificate
- 1 Hilti toolbox

3 Accessories

PP 10 / 11 accessories

Designation
PPA 83 battery holder (size D cells)
PPA 84 connecting cable (12V)
PPA 70/71/72 vertical and horizontal adapter
PPA 73 tripod adaptor
PPA 40 telescopic sight

4 Technical data

Right of technical changes reserved.

NOTE

Right of technical changes reserved.

Wavelength, PP 10	633 nm
Wavelength, PP 11	532 nm
Accuracy	Temperature +24°C (75°F), Horizontal distance 10 m (33 ft): -0.5...0.5 mm (1/8")
Laser class: class 3R	As per IEC 825- 1:2003
Laser class: class IIIa	As per CFR 21 § 1040 (FDA)
Laser beam diameter	12 mm (1/2")
Self-leveling range	-10... 10%
Inclination range	-15... 40%
Min. inclination setting	0.001%
Battery life (PP10)	Temperature +20°C (+68°F), Alkaline manganese: 70 h Temperature +20°C (+68°F), NiMH: Min. 48 h
Battery life (PP11)	Temperature +20°C (+68°F), Alkaline manganese: 45 h Temperature +20°C (+68°F), NiMH: Min. 32 h
Operating temperature range	-20... +50°C (-4 to 122°F)
Storage temperature range	-30... +60°C (-22 to 140°F)
Water and dust resistant	Depth of submersion 5 m (15 ft), Duration of submersion 24 h: Yes
Weight (including 4 batteries)	3.8 kg (8 lbs 6 oz)
Dimensions (∅)	Without grip: 122 mm (4 7/8") x 330 mm (13")

Automatic target plate recognition

Range	5... 150 m (15 to 500 ft)
-------	---------------------------

5 Safety instructions

5.1 Basic information concerning safety

The tool is designed to be used for determining, transferring or checking alignment in the horizontal and inclined planes.

In addition to the information relevant to safety given in each of the sections of these operating instructions, the following points must be strictly observed at all times.

5.2 Misuse

- The tool and its ancillary equipment may present hazards when used incorrectly by untrained personnel or when used not as directed.**
- To avoid the risk of injury, use only genuine Hilti accessories and additional equipment.**
- Modification of the tool is not permissible.**
- Observe the information printed in the operating instructions concerning operation, care and maintenance.**
- Do not render safety devices ineffective and do not remove information and warning notices.**
- Keep laser tools out of reach of children.**

- Failure to follow the correct procedures when opening the tool may cause emission of laser radiation in excess of class 3. **Have the tool repaired only at a Hilti service center.****
- Take the influences of the surrounding area into account. Do not use the tool where there is a risk of fire or explosion.**
- (Statement in accordance with FCC §15.21): Changes or modifications not expressly approved by the manufacturer can void the user's authority to operate the equipment.

5.3 Proper organization of the work area

- Secure the area in which you are working and take care to avoid directing the beam towards other persons or towards yourself when setting up the tool.**
- Measurements taken through panes of glass or other objects may be inaccurate.
- Ensure that the tool is set up on a steady, level surface (not subject to vibration).**

- d) **Use the tool only within its specified limits.**

5.3.1 Electromagnetic compatibility

Although the tool complies with the strict requirements of the applicable directives, Hilti cannot entirely rule out the possibility of the tool being subject to interference caused by powerful electromagnetic radiation, leading to incorrect operation. Check the accuracy of the tool by taking measurements by other means when working under such conditions or if you are unsure. Likewise, Hilti cannot rule out the possibility of interference with other devices (e.g. aircraft navigation equipment).

5.3.2 Laser classification for tools of the classes 3R and IIIa

- a) The tool conforms with laser class 3R in accordance with IEC 825-1:2003 and class IIIa in accordance with 21 CFR § 1040(FDA).
- b) Tools of the laser class 3R and class IIIa should be operated by trained personnel only.
- c) The area in which the tool is in use must be marked with laser warning signs.
- d) The plane of the laser beam should be well above or well below eye level.
- e) Precautions must be taken to ensure that the laser beam does not unintentionally strike highly reflective surfaces.
- f) Precautions must be taken to ensure that persons do not stare directly into the beam.
- g) The laser beam must not be allowed to project beyond the controlled area.
- h) When not in use, laser tools should be stored in a place to which unauthorized persons have no access.

5.4 General safety rules

- a) **Check the condition of the tool before use. If the tool is found to be damaged, have it repaired at a Hilti service center.**
- b) **The user must check the accuracy of the tool after it has been dropped or subjected to other mechanical stresses.**
- c) **When the tool is brought into a warm environment from very cold conditions, or vice-versa, allow it to become acclimatized before use.**
- d) **If mounting on an adapter, check that the tool is screwed on securely.**
- e) **Keep the laser exit aperture clean to avoid measurement errors.**
- f) **Although the tool is designed for the tough conditions of jobsite use, as with other optical and electronic instruments (e.g. binoculars, spectacles, cameras) it should be treated with care.**
- g) **Although the tool is protected to prevent entry of dampness, it should be wiped dry each time before being put away in its transport container.**
- h) **Check the tool before using it for important measuring work.**
- i) **Check the accuracy of the measurements several times during use of the tool.**

5.4.1 Electrical

- a) **Keep the batteries out of reach of children.**
- b) **Do not allow the batteries to overheat and do not expose them to fire.** The batteries may explode or release toxic substances.
- c) **Do not charge the batteries.**
- d) **Do not solder the batteries into the tool.**
- e) **Do not discharge the batteries by short circuiting as this may cause them to overheat and present a risk of personal injury (burns).**
- f) **Do not attempt to open the batteries and do not subject them to excessive mechanical stress.**

6 Before use



NOTE

The tool may be powered only by the PPA 82 battery or by batteries manufactured in accordance with IEC 285.

NOTE

Do not use damaged batteries, do not mix old and new batteries and do not mix batteries from various manufacturers or batteries with different type designations.

6.1 Switching the tool on

Press the ON / OFF button.

NOTE

The PP 10/11 is capable of leveling itself within a range of +/- 10%. The tool levels itself automatically when set up within this range. The LED begins to blink when the inclination of the tool is more than +/- 10% from the set inclination. The tool should then be rotated in the direction indicated by the arrow.

6.2 Battery warning indicator

①

Adequate voltage

The tool can be used.

②	Low voltage	The tool can still be used.
③	The battery is discharged.	Charge the NiMH battery or insert new alkaline batteries.
④	The display blinks	The PPA 84 12V connecting cable is used for charging the laser tool.

6.3 Removing the PPA 83 battery holder or PPA 82 battery

1. Turn the battery locking knob to "OPEN" and remove the battery holder.
2. In addition, the battery compartment in the PPA 83 battery box can be opened. To do this, turn the knob on the battery compartment cover to the "OPEN" position.

6.4 Replace the batteries.

1. Replace the used batteries in the battery holder with new ones.

6.5 Fitting the PPA 83 battery holder or PPA 82 battery

1. Refit the battery holder after replacing the batteries.
2. Turn the knob to the "LOCK" position.

6.6 Connecting the PPA 84 cable

NOTE

If using a battery fitted to a motor vehicle, please first switch off the engine.

NOTE

Take care to ensure correct polarity when connecting both terminals.

NOTE

Switch the tool off before connecting or disconnecting the external power cable.

The connecting cable is designed for connecting to a 12 V battery.

1. Connect the red clip to the positive (+) pole.
2. Connect the black clip to the negative (-) pole.

6.7 Charging the PPA 82 battery

Charging should take place in a room where the temperature is between +10°C and +40°C.

The battery is charged automatically when the laser is operated at a temperature of [+10°C to +40°C] with an external battery.

1. Fit the PPA 81 charging adapter to the PPA 82 battery.
2. Connect the power supply unit to the charging adapter.
3. Plug the power supply unit into a power outlet.
4. Check that the correct voltage has been set on the power supply unit.

The charging control lamp lights green when the charging operation is complete.

6.8 Charging status

Charging status	Red LED lights	Charging
	Green LED lights	Charging completed
	Blinks green	Error during charging
	Blinks red	The protective cut-out has been activated. The PP 10 / 11 may be used while in this status.

7 Operation

7.1 Button functions

①	Plumb spot button	Switches the plumb spot on and off (switches off automatically after 30 minutes).
②	Laser beam mode button	The laser beam can be switched over by pressing the laser beam mode button. PP 10: constant beam or blinking beam PP 11: constant beam, blinking beam, high-power mode
③	"Lock" button	This button locks all data entry functions. Values can then no longer be changed. The data entry functions can be unlocked by pressing the LOCK button again.
④	Target plate auto-centering button	The laser beam finds the center of the target plate automatically.
⑤	Direction control	Moves the laser beam to the left or right.

⑤	Parameter selection	Used to select the parameters to be set.
⑤	Automatic centering	The laser beam centers itself automatically when both direction control buttons are pressed at the same time.
⑥	Laser beam up / down	Moves the laser beam up or down.
⑥	Value entry	Positive or negative values may be entered. When both buttons are pressed at the same time, inclination is set automatically to 00.000%.
⑦	SET button	This button is used to confirm the selected parameters.
⑧	ON / OFF button	This button is used to switch the tool on or off.

7.2 Symbols in the display 4

①	Plumb spot indicator.	Shows that the plumb spot is active.
②	Alignment indicator	Indicates laser beam alignment.
③	Battery status indicator	Remaining battery capacity is shown in 3 levels.
④	Self-leveling indicator	Blinks while the laser is leveling itself. The display subsequently changes to the laser mode set.
⑤	Inclination indicator	Shows the selected inclination.
⑥	Percentage	Shows the unit of measurement selected (percentage or per thousand).
⑦	Lock symbol	The values entered cannot be changed.
⑧	Electronic bubble level	Shows whether the tool is leveled correctly.
⑨	Laser mode display	The laser modes "blinking", "normal" and "high-power" (PP11) are shown.

7.3 Warnings displayed 5

①	Battery status warning	Operation is no longer possible. Replace / recharge the battery or connect an external power source.
②	Leveling warning	The laser is tilted beyond its self-leveling range. Tilt the laser tool in the direction of the arrow shown in the display.
③	Transverse inclination warning	The laser tool has been rotated beyond its self-leveling range. Rotate the laser tool in the direction of the arrow shown in the display.

7.4 Switching the tool on

Press the ON / OFF button.

NOTE

The PP 10/11 is capable of leveling itself within a range of +/- 10%. The tool levels itself automatically when set up within this range. The LED begins to blink when the inclination of the tool is more than +/- 10% from the set inclination. The tool should then be rotated in the direction indicated by the arrow.

7.5 Setting the inclination 6

Inclination can be set either manually or automatically. Inclination can be set within the -15% to +40% range (for inclinations over 10%, an accessory or other aid is used to provide initial inclination of the laser tool).

7.5.1 Automatic entry of inclination 6

1. Switch the tool on by pressing the ON / OFF button.
2. Press the SET button. The set value is displayed and the \pm indicator blinks.
3. Press the laser beam UP or DOWN button to change the sign.

4. Press the right-hand direction control button in order to reach the correct position (the left direction control button can be used to move back).
5. Press the laser beam UP or DOWN button to change the value.
6. Press the right-hand direction control button to move to the next position.
7. Press the laser beam UP or DOWN button to change the value. Repeat the steps described above to change other numerical values.
8. Press the SET button when the value entered is correct. The laser beam then begins to move to the specified setting.

7.5.2 Manual entry of inclination

NOTE

Inclination can also be set directly by moving the laser beam. Check that the locking function has not been activated.

The value indicated becomes higher or lower as the laser beam is moved.

1. Press the laser beam UP or DOWN button. The laser beam then moves up or down.

2. Press the laser beam UP and DOWN buttons at the same time to move the laser beam to the zero position.
The laser beam moves immediately to the 0.000% position.

7.6 Aligning the target line 7

Use the direction control buttons on the PP 10/11 or PPA 20 remote control unit to move the laser beam horizontally to the right or left.

7.7 Beam position indicator 7

①	Beam position indicator	Shows the direction of the laser beam relative to the tool.
②	End position left	Shows that the laser beam cannot be aimed further to the left.
③	End position right	Shows that the laser beam cannot be aimed further to the right.

7.8 Adjusting the position of the beam 7

The maximum lateral adjustment range is 9m at a distance of 30m. The speed of movement can be varied.

If the button is pressed briefly, the laser beam moves slowly.

If the button is pressed for longer, the laser beam moves quickly.

The current position of the beam can be read from the display at any time.

If this position is reached frequently it is recommended that the tool is pivoted slightly to the left or right and the beam then realigned.

7.9 Automatic centering

Press the two direction control buttons (left and right) at the same time.

The laser beam returns to the center automatically.

7.8.1 Adjusting the beam end position left / right

The display informs the operator when the beam has reached the left or right end position and cannot be moved further. The display blinks to inform the operator of this status.

7.10 Automatic alignment with the target plate 8

1. Set up the target plate with the reflective stripes facing the laser tool.
2. Press the target plate auto-centering button.
NOTE This function may take up to 2 minutes before starting.
The tool then searches for the target plate within its alignment range (left/right).

7.11 Display while searching 8

①	The laser tool is not yet ready for automatic alignment.	The tool has not yet completed the self-leveling procedure. NOTE This procedure will first be completed.
②	The display indicates stabilization of the laser beam after self-leveling.	Please wait until this operation has been completed.
③	The display indicates that searching (auto centering) is in progress.	Searching (auto centering) then begins.
④	Automatic alignment has been completed.	Check the position of the laser spot on the target plate. NOTE If necessary, the remote control or the direction control buttons on the tool (left / right) can be used to readjust the position of the beam.
⑤	Error during automatic alignment.	If the beam loses contact with the target plate while searching, the procedure must be restarted.

7.12 Selecting the laser beam mode

Press the laser beam mode button as often as necessary until the desired display mode is shown in the display.

Constant beam

Blinking beam

High-power mode (only with the PP 11)

7.13 Adjusting the electronic bubble level 9

When the tool is pivoted, the bubble level appears clearly in the display.

Adjust the tool until the "bubble" is in the center of the display.

The LED begins to blink as soon as the tool's compensation range is exceeded.

7.14 Fitting the screw feet and centering screw

Fit the appropriate feet for the pipe diameter before setting up the laser in the pipe.

7.16 Target plate, front

①	Locking screw	Secures the target plate at the desired height.
②	Target plate, small	Target plate for 150 mm to 250 mm.
③	Bubble level	For setting up the target plate horizontally.
④	Target plate holder	For automatic alignment.

7.17 Target plate, rear (2)

⑤	Reflective stripes (only for the PP 11)
---	---

7.18 Setting parameters

7.18.1 Setting units of measurement to % or ‰

1. Press the ON / OFF button and the LOCK button at the same time.
The set values are shown in the display.
2. Use the laser beam UP / DOWN button to move to the "unit" line.
3. Select the value you wish to change by pressing the direction control button.
4. Press the SET button to confirm the entry.
The tool then returns to the normal operating mode.

7.18.2 Setting and activating the security code

Unauthorized persons can be prevented from using the laser tool by entering a 4-digit security code. Please note that once the security code has been activated, the laser tool can no longer be operated without entering this code. The code will be requested automatically after the tool is switched on.

1. Press the ON / OFF button and the LOCK button at the same time.
The set values are shown in the display.
2. Use the laser beam UP / DOWN button to move to the "input S code" line.
3. Press the SET button to enter the correct mode.
4. The laser beam UP / DOWN button and direction control button can be used to navigate to the corresponding number. Press the SET button to confirm the number selected. Press the SET button to confirm the code as soon as the four desired digits are displayed in the "code" area of the display.

NOTE

Feet are available in the sizes 150 mm, 200 mm, 250 mm and 300 mm (6", 8", 10", 12").

7.15 Setting the target plate size

Set the target plate size to a value suitable for the pipe diameter you are working with.

5. The display then returns to the previous mode. The security code can then be activated ("on" by pressing the SET button) or deactivated later ("off" by pressing the SET button again).
The tool then returns to the normal operating mode.

7.18.3 Entering the name of the company

These instructions describe how to enter or change the name of the company. A maximum of 32 characters (16 characters in 2 rows) can be entered.

1. Press the ON / OFF button and the LOCK button at the same time.
The set values are shown in the display.
2. Use the laser beam UP / DOWN button to move to the "change name" line.
3. Press the SET button to enter the correct mode.
4. Use the laser beam UP / DOWN button and direction control button to navigate to the corresponding characters / digits. Press the SET button to confirm the character selected. Press the SET button to confirm the entry as soon as the correct name / designation is displayed.
The tool then returns to the normal operating mode.

7.19 Checking the tool's accuracy

1. Set the laser to an inclination of 0.000%.
2. Set up a leveling staff at a distance of 1m and a second leveling staff at a distance of 60m. Note the heights at which the laser beam strikes the staffs.
3. Set up an optical level in the middle between the two leveling staffs and read the heights from both staffs.
4. Calculate the difference in height indicated by the optical level and the rotating laser on staffs 1 and 2. If both values are identical, then the laser tool is correctly adjusted.

NOTE If the differences X1 and X2 are not equal, please contact your local Hilti Center or Hilti representative.

8 Care and maintenance

8.1 Cleaning and drying

1. Blow dust off the lenses.
2. Do not touch the glass with your fingers.
3. Use only a clean, soft cloth for cleaning. If necessary, moisten the cloth slightly with pure alcohol or a little water.

NOTE Do not use any other liquids as these may damage the plastic components.

4. Observe the temperature limits when storing your equipment. This is particularly important in winter / summer if the equipment is kept inside a motor vehicle (-30°C to +60°C).

8.2 Storage

Remove the tool from its case if it has become wet. The tool, its carrying case and accessories should be cleaned and dried (at maximum 40°C / F). Repack the equipment only once it is completely dry.

Check the accuracy of the equipment before it is used after a long period of storage or transportation.

Remove the batteries from the tool before storing it for a long period.

8.3 Transport

Use the Hilti toolbox or packaging of equivalent quality for transporting or shipping your equipment.

CAUTION

Always remove the batteries before shipping the tool.

8.4 Hilti calibration service

We recommend that the tool is checked by the Hilti calibration service at regular intervals in order to verify its reliability in accordance with standards and legal requirements.

Use can be made of the Hilti calibration service at any time, but checking at least once a year is recommended. The calibration service provides confirmation that the tool is in conformance, on the day it is tested, with the specifications given in the operating instructions.

The tool will be readjusted if deviations from the manufacturer's specification are found. After checking and adjustment, a calibration sticker applied to the tool and a calibration certificate provide written verification that the tool operates in accordance with the manufacturer's specification.

Calibration certificates are always required by companies certified according to ISO 900x.

Your local Hilti Center or representative will be pleased to provide further information.

9 Troubleshooting

Fault	Possible cause	Remedy
E02/03	An internal measurement problem has occurred.	Switch the tool off and then on again. An error message may be displayed if the tool is knocked or shaken. In this case, eliminate the cause of the disturbance.
E99	An internal memory problem has occurred.	Switch the tool off and then on again.
ERROR	The tool was moved while in standby mode.	Switch the tool off and then on again and check that it is set up correctly. NOTE Contact your nearest Hilti Service Center if the fault persists.

10 Disposal

WARNING

Improper disposal of the equipment may have serious consequences:

The burning of plastic components generates toxic fumes which may present a health hazard.

Batteries may explode if damaged or exposed to very high temperatures, causing poisoning, burns, acid burns or environmental pollution.

Careless disposal may permit unauthorized and improper use of the equipment. This may result in serious personal injury, injury to third parties and pollution of the environment.



Most of the materials from which Hilti tools or appliances are manufactured can be recycled. The materials must be correctly separated before they can be recycled. In many countries, Hilti has already made arrangements for taking back old tools and appliances for recycling. Ask Hilti customer service or your Hilti representative for further information.

en



For EC countries only

Disposal of electric tools together with household waste is not permissible.

In observance of the European Directive on waste electrical and electronic equipment and its implementation in accordance with national law, electrical appliances that have reached the end of their life must be collected separately and returned to an environmentally compatible recycling facility.



Dispose of the batteries in accordance with national regulations.

11 Manufacturer's warranty - tools

Please contact your local Hilti representative if you have questions about the warranty conditions.

12 EC declaration of conformity (original)

Designation:	Pipe laser
Type:	PP 10 / 11
Year of design:	2005

Technical documentation filed at:

Hilti Entwicklungsgesellschaft mbH
Zulassung Elektrowerkzeuge
Hiltistrasse 6
86916 Kaufering
Deutschland

We declare, on our sole responsibility, that this product complies with the following directives and standards: until 19th April 2016: 2004/108/EC, from 20th April 2016: 2014/30/EU, 2011/65/EU, 2006/66/EC, EN ISO 12100.

**Hilti Corporation, Feldkircherstrasse 100,
FL-9494 Schaan**

Paolo Luccini
Head of BA Quality and Process Management
Business Area Electric Tools & Accessories
06/2015

Edward Przybyłowicz
Head of BU Measuring Systems
BU Measuring Systems
06/2015



Hilti Corporation

LI-9494 Schaan

Tel.: +423/234 21 11

Fax: +423/234 29 65

www.hilti.com

Hilti = registered trademark of Hilti Corp., Schaan
Pos. 1 | 20151016

