



DSW 1510-CA

English

DSW 1510-CA

Original operating instructions

Original operating instructions

Contents

1	Information about the documentation	3
1.1	About this documentation	3
1.2	Explanation of symbols used	3
1.2.1	Warnings	3
1.2.2	Symbols in the documentation	3
1.2.3	Symbols in the illustrations	4
1.3	Additional symbols for this product	4
1.3.1	Symbols on the type identification plate	4
1.3.2	Hazard warning symbols	4
1.3.3	Obligation symbols	4
1.3.4	Prohibition symbols	4
1.4	Product information	5
1.5	Declaration of conformity	5
2	Safety	5
2.1	General power tool safety warnings	5
2.2	Proper arrangement of the workplace	7
2.3	Protection against electric shock	8
2.4	Safety during operation	8
2.5	Safety concept for working with wire saws	9
2.5.1	Description of the danger zone	10
2.5.2	Danger zone A (shown here colored yellow)	10
2.5.3	Danger zone B (shown here colored gray)	10
2.6	Requirements to be met by operating personnel	10
3	Description	11
3.1	Product overviews	11
3.1.1	System components	11
3.1.2	DSW 1510-CA drive unit	12
3.1.3	Transport devices	12
3.1.4	Operating panel	13
3.1.5	DSW-SPP 240 pulley stand	13
3.2	Intended use	13
3.3	Items supplied	14
3.4	Stickers on the product	14
3.5	Operating principle	14
4	Technical data	15
4.1	DSW 1510-CA drive unit	15
4.2	Water supply	15
4.3	Air compressor	15



4.4	DST WRC-CA wireless remote control unit	15
4.5	Noise emission values	15
4.6	DSW-SPP 240 single-pulley stand	16
5	Tools and accessories	16
5.1	DS-W diamond wires	16
5.2	Accessories for diamond wire saws	16
5.3	Accessories and wear parts for the wire saw system	17
6	Preparations at the workplace	17
6.1	Planning and safety	17
6.1.1	Planning the cuts to be made	17
6.1.2	Planning wire guidance and sequence of cuts	17
6.1.3	Safety aspects to be clarified prior to installation	17
6.2	Examples of wire guidance	18
6.3	Determination of storage capacity needed and necessary wire length	20
6.4	Power supply and fuse rating	20
6.5	Use of extension cables	21
6.6	Requirements to be met by the cooling water supply	21
7	Before use	21
7.1	Location and connections	21
7.1.1	Requirements to be met by the set-up location	21
7.1.2	Setting up drive unit	22
7.1.3	Drilling through-holes for wire guidance	22
7.1.4	Fastening a pulley stand	23
7.1.5	Connecting the electricity supply, water and compressed air	23
7.2	Pairing DST WRC-CA wireless remote control	24
7.3	Diamond wire	25
7.3.1	Fitting wire connectors and connection of diamond wire	25
7.3.2	Diamond-wire path and cutting direction	25
7.3.3	Laying diamond wire on to pulleys	25
7.3.4	Check of diamond wire / guide pulley alignment (slack-wire side)	26
7.3.5	Tensioning diamond wire	27
7.3.6	Setting up cooling of the diamond wire	27
7.3.7	Fitting the guards	27
8	Operation	28
8.1	Checks before beginning sawing	28
8.2	Starting drive unit and beginning sawing	28
8.3	During operation of the wire saw	29
8.4	Changing storage levels	29
8.5	Shutting down drive unit (interrupting sawing operation)	30
8.6	Shutting down drive unit (ending sawing operation)	30



9	Care and maintenance	31
9.1	Cleaning drive unit	31
9.2	Blow remaining traces of water out of the cooling water circuit and motors	32
9.3	Carrying out maintenance	32
9.4	Replacing rubber-tired pulleys on the DSW-SPP 240 single-pulley stand	33
10	Transport and storage	34
10.1	Transporting drive unit	34
11	Troubleshooting table	35
12	Fault codes	37
13	Disposal	38
14	Manufacturer's warranty	39

1 Information about the documentation

1.1 About this documentation

- Read this documentation before initial operation or use. This is a prerequisite for safe, trouble-free handling and use of the product.
- Observe the safety instructions and warnings in this documentation and on the product.
- Always keep the operating instructions with the product and make sure that the operating instructions are with the product when it is given to other persons.

1.2 Explanation of symbols used

1.2.1 Warnings

Warnings alert persons to hazards that occur when handling or using the product. The following signal words are used:

DANGER

DANGER !

- ▶ Draws attention to imminent danger that will lead to serious personal injury or fatality.

WARNING

WARNING !

- ▶ Draws attention to a potential threat of danger that can lead to serious injury or fatality.

CAUTION

CAUTION !

- ▶ Draws attention to a potentially dangerous situation that could lead to personal injury or damage to the equipment or other property.

1.2.2 Symbols in the documentation

The following symbols are used in this document:



Read the operating instructions before use.



Instructions for use and other useful information



	Dealing with recyclable materials
	Do not dispose of electric equipment and batteries as household waste

1.2.3 Symbols in the illustrations

The following symbols are used in illustrations:

2	These numbers refer to the corresponding illustrations found at the beginning of these operating instructions
3	The numbering reflects the sequence of operations shown in the illustrations and may deviate from the steps described in the text
⑪	Item reference numbers are used in the overview illustrations and refer to the numbers used in the product overview section
	This symbol is intended to draw special attention to certain points when handling the product.

1.3 Additional symbols for this product

1.3.1 Symbols on the type identification plate

The following symbols are used on the type identification plate:

/min	Revolutions per minute
n_0	Rated speed under no load
∅	Diameter

1.3.2 Hazard warning symbols

The following hazard symbols are used on the product:

	Warning: hazardous electrical voltage
--	---------------------------------------

1.3.3 Obligation symbols

The following obligation symbols are used on the product:

	Wear eye protection
	Wear a hard hat
	Wear ear protection
	Wear protective gloves
	Wear safety shoes
	Lifting points

1.3.4 Prohibition symbols

The following prohibition symbols are used on the product:

	Do not grip the diamond wire!
--	-------------------------------



	Do not enter the danger zone!
	Use of high-pressure cleaning equipment prohibited
	Do not cross the danger zone!

1.4 Product information

products are designed for professional users and only trained, authorized personnel are permitted to operate, service and maintain the products. This personnel must be specifically informed about the possible hazards. The product and its ancillary equipment can present hazards if used incorrectly by untrained personnel or if used not in accordance with the intended use.

The type designation and serial number are printed on the rating plate.

- ▶ Write down the serial number in the table below. You will be required to state the product details when contacting Hilti Service or your local Hilti organization to inquire about the product.

Product information

Wire saw	DSW 1510-CA
Generation	01
Serial no.	

1.5 Declaration of conformity

We declare, on our sole responsibility, that the product described here complies with the applicable directives and standards. A copy of the declaration of conformity can be found at the end of this documentation.

The technical documentation is filed here:

Hilti Entwicklungsgesellschaft mbH | Tool Certification | Hiltistrasse 6 | 86916 Kaufering, Germany

2 Safety

2.1 General power tool safety warnings

WARNING Read all safety warnings, instructions, illustrations and specifications provided with this power tool. Failure to follow all instructions listed below may result in electric shock, fire and/or serious injury.

Save all warnings and instructions for future reference.

The term "power tool" in the warnings refers to your mains-operated (corded) power tool or battery-operated (cordless) power tool.

Work area safety

- ▶ **Keep work area clean and well lit.** Cluttered or dark areas invite accidents.
- ▶ **Do not operate power tools in explosive atmospheres, such as in the presence of flammable liquids, gases or dust.** Power tools create sparks which may ignite the dust or fumes.
- ▶ **Keep children and bystanders away while operating a power tool.** Distractions can cause you to lose control.



Electrical safety

- ▶ **Power tool plugs must match the outlet. Never modify the plug in any way. Do not use any adapter plugs with earthed (grounded) power tools.** Unmodified plugs and matching outlets will reduce risk of electric shock.
- ▶ **Avoid body contact with earthed or grounded surfaces, such as pipes, radiators, ranges and refrigerators.** There is an increased risk of electric shock if your body is earthed or grounded.
- ▶ **Do not abuse the cord. Never use the cord for carrying, pulling or unplugging the power tool. Keep cord away from heat, oil, sharp edges or moving parts.** Damaged or entangled cords increase the risk of electric shock.
- ▶ **When operating a power tool outdoors, use an extension cord suitable for outdoor use.** Use of a cord suitable for outdoor use reduces the risk of electric shock.

Personal safety

- ▶ **Stay alert, watch what you are doing and use common sense when operating a power tool. Do not use a power tool while you are tired or under the influence of drugs, alcohol or medication.** A moment of inattention while operating power tools may result in serious personal injury.
- ▶ **Use personal protective equipment. Always wear eye protection.** Protective equipment such as a dust mask, non-skid safety shoes, hard hat or hearing protection used for appropriate conditions will reduce personal injuries.
- ▶ **Prevent unintentional starting. Ensure the switch is in the off-position before connecting to power source and/or battery pack, picking up or carrying the tool.** Carrying power tools with your finger on the switch or energising power tools that have the switch on invites accidents.
- ▶ **Remove any adjusting key or wrench before turning the power tool on.** A wrench or a key left attached to a rotating part of the power tool may result in personal injury.
- ▶ **Do not overreach. Keep proper footing and balance at all times.** This enables better control of the power tool in unexpected situations.
- ▶ **Dress properly. Do not wear loose clothing or jewellery. Keep your hair and clothing away from moving parts.** Loose clothes, jewellery or long hair can be caught in moving parts.
- ▶ **If devices are provided for the connection of dust extraction and collection facilities, ensure these are connected and properly used.** Use of dust collection can reduce dust-related hazards.
- ▶ **Do not let familiarity gained from frequent use of tools allow you to become complacent and ignore tool safety principles.** A careless action can cause severe injury within a fraction of a second.

Power tool use and care

- ▶ **Do not force the power tool. Use the correct power tool for your application.** The correct power tool will do the job better and safer at the rate for which it was designed.
- ▶ **Do not use the power tool if the switch does not turn it on and off.** Any power tool that cannot be controlled with the switch is dangerous and must be repaired.
- ▶ **Disconnect the plug from the power source and/or remove the battery pack, if detachable, from the power tool before making any adjustments, changing accessories, or storing power tools.** Such preventive safety measures reduce the risk of starting the power tool accidentally.
- ▶ **Store idle power tools out of the reach of children and do not allow persons unfamiliar with the power tool or these instructions to operate the power tool.** Power tools are dangerous in the hands of untrained users.



- ▶ **Maintain power tools and accessories. Check for misalignment or binding of moving parts, breakage of parts and any other condition that may affect the power tool's operation. If damaged, have the power tool repaired before use.** Many accidents are caused by poorly maintained power tools.
- ▶ **Keep cutting tools sharp and clean.** Properly maintained cutting tools with sharp cutting edges are less likely to bind and are easier to control.
- ▶ **Use the power tool, accessories and tool bits etc. in accordance with these instructions, taking into account the working conditions and the work to be performed.** Use of the power tool for operations different from those intended could result in a hazardous situation.
- ▶ **Keep handles and grasping surfaces dry, clean and free from oil and grease.** Slippery handles and grasping surfaces do not allow for safe handling and control of the tool in unexpected situations.

2.2 Proper arrangement of the workplace

- ▶ Approval must be obtained from the site engineer or site management before beginning drilling and sawing work. Drilling and sawing work on buildings and other structures can influence the statics, especially when steel reinforcing bars and load-bearing components are cut through.
- ▶ Jointly with site management, make sure that no gas, water, electricity or other lines are located in the cutting area. Use existing drawings and, for example, a detector for this purpose. External metal parts on the device can become live, for example if you inadvertently damage electric wiring. Lines in the vicinity of the cutting zone that could be damaged by falling parts, for example, have to be specially protected and, if necessary, temporarily taken out of service.
- ▶ Ensure that good lighting is in use.
- ▶ Make sure that the workplace is well ventilated. Poorly ventilated workplaces can result in damage to health because of exposure to dust.
- ▶ Keep the workplace tidy. Objects which could cause injury should be removed from the working area. Untidiness at the workplace can lead to accidents.
- ▶ In order to avoid injuries and to prevent the diamond wire becoming trapped and stuck, steel wedges and/or supports must be used to prevent movement of objects that are being cut free.
- ▶ Ensure that adequately-sized supports are correctly installed so that the remaining structure maintains its stability after completion of the cutting work and removal of the part cut away.
- ▶ Never loiter in areas where loads are suspended by crane or lifting equipment.
- ▶ The area of the cut or the opening created by the cutting process must be safely and visibly cordoned off in order to avoid the risk of persons falling.
- ▶ Wear personal protective equipment. Wear safety footwear, protective gloves, a hard hat and protective glasses.
- ▶ Dust from materials such as paint containing lead, some types of wood, minerals and metal can be harmful to health. Contact with or inhalation of the dust can cause allergic reactions and/or respiratory or other diseases to the operator or bystanders. Certain kinds of dust such as oakwood and beechwood dust are classified as carcinogenic, especially in conjunction with additives for wood conditioning (chromate, wood preservative). Only specialists are permitted to work on material containing asbestos. Use a dust-extraction device wherever possible. To achieve a high level of dust extraction, use a suitable vacuum extractor of a type that is recommended by **Hilti** for wood dust and/or mineral dust and which is designed for use with this power tool. Make sure that the workplace is well ventilated. It is advisable to wear a filter class P2



dust mask. Comply with national regulations applicable to the materials you will be working with.

- ▶ Wear suitable work clothes. Do not wear jewelry or loose clothing that could be snagged by moving parts. If your hair is long, wear a hair net.
- ▶ Avoid skin contact with drilling and sawing slurry.
- ▶ Keep children clear. Keep everyone clear of your work zone.
- ▶ Do not allow other persons to touch the equipment or the extension cord.
- ▶ Always run cables and hoses flat on the floor or ground away from the machine to prevent trip hazards.
- ▶ Keep cables and hoses away from rotating parts.
- ▶ Ensure that the cooling water used is drained or extracted in a suitably controlled manner. Cooling water allowed to drain away or spray around in an uncontrolled manner can lead to damage and accidents. Also bear in mind that water can drain away through hidden internal cavities.

2.3 Protection against electric shock

- ▶ Check the machine's connecting cables at regular intervals and if they are damaged, have them replaced by a qualified specialist. Check the extension cords at regular intervals and replace them if they are damaged.
- ▶ Do not touch an electric cable damaged while work is in progress. Switch off the main switch and unplug the supply cord from the electric supply.
- ▶ Damaged or faulty switches must be replaced at a **Hilti** service center. Do not use a machine, power tool or appliance that cannot be switched on and off at the main switch.
- ▶ Have the machine, power tool or appliance repaired only by a trained electrical specialist (**Hilti** Service) using genuine Hilti spare parts. Failure to observe this point can put the user at risk.
- ▶ Connect the machine and its ancillary equipment only to a power source equipped with an earth/ground conductor and a residual current device (RCD). Check that these items are in perfect working order before operating the equipment. If a generator is used, connect it to a grounding/earthing rod driven into the ground.
- ▶ Make sure that the mains voltage corresponds to the specification given on the type plate.
- ▶ Keep electric cables and especially their plug connectors dry. Close power outlets with the covers provided when not in use.
- ▶ Use only extension cables of a type approved for the application and with conductors of adequate cross section. Do not work with rolled-up extension cables. A rolled-up cable may cause a drop in power and may result in the cable overheating.
- ▶ Note that components of the power converter can still be under fatally high voltage for up to 10 minutes after disconnection from the electric supply.

2.4 Safety during operation

- ▶ Before use, check that the wire saw and its components, the wire and its connectors as well as the accessories are in good condition and in perfect working order. Make sure that any damage or malfunctions are rectified in a professional manner before operation commences.
- ▶ Take up a position as far as possible away from the danger zone. Position yourself where you have the cutting process and the danger zone in clear view.
- ▶ Carry the wireless remote control with you at all times so that you can interrupt the cutting process immediately if a dangerous situation occurs.



- ▶ Do not start work until the drive unit and the pulley stands have been securely and firmly secured to a solid sub-base. A toppling or dropped part can result in serious damage or injury.
- ▶ Connect the electric power and compressed air supply only once the wire saw has been set up completely.
- ▶ Do not start up the product before all covers have been correctly installed and closed.
- ▶ Entry into the danger zone (e.g. to adjust the pulleys or water supply, hammer in wedges, etc.) is permissible only after the **EMERGENCY STOP** button or the ON/OFF switch on the remote control unit has been pressed and the drive pulleys have come to a standstill.
- ▶ Adhere to the permissible drive unit parameters and recommended guide values for wire speed and advance pressure while sawing.
- ▶ Use only sawing wires that comply with the requirements of EN 13236. Use only one wire connector per diamond-wire loop and connect only diamond wires of the same type and diameter.
- ▶ The number of wire breakages experienced can be reduced considerably by using high-quality wires and wire connectors and the appropriate crimping tools for fitting connectors.
- ▶ The sawing wire can become hot, so do not touch it unless you are wearing protective gloves.
- ▶ Use only fastening materials of adequate size (anchors, bolts, etc.) to fasten the pulley stands for the wire saw and to secure the object being cut.
- ▶ If equipment such as scaffolding, platforms or ladders is used, check that this equipment complies with regulations, that it is undamaged and set up in accordance with regulations.
- ▶ Avoid awkward postures. Maintain firm footing and balance at all times.
- ▶ At all times while the saw is in operation, the operator must ensure that no persons are present in the danger zone. This also applies to the area not immediately visible to the operator, i.e. the area behind or below the object in which the cut is being made. If necessary, a large area must be cordoned off or security personnel posted.
- ▶ Stay alert at all times. Keep the sawing process and the surroundings of the working area under observation. Do not operate the machine if your full attention is not on the job.
- ▶ Modifications to the saw system are prohibited. Changes to the ex-works settings of the frequency converter parameters are prohibited.

2.5 Safety concept for working with wire saws

Operate the wire saw only when you and all other persons are as far as possible outside all danger zones. By adopting additional measures (e.g. setting up cordons or posting guards), make sure that no-one enters these danger zones while the equipment is in operation. Danger zones extend also to the areas that are hard to see or cannot be seen from in front (e.g. the rear of the structure to be cut).

Notes for safe working practice:

- Never enter the area underneath the work zone while the equipment is being set up and while the wire saw is in operation. Falling parts can cause serious injuries.
- Invariably, keep a safe distance of at least 2 m away from all parts that move while the equipment is in operation.



2.5.1 Description of the danger zone

The danger zone for wire saws includes zones in which:

- **(A)** Persons could be hit by a whipping diamond wire.
- **(B)** Persons could be hit by flying parts.

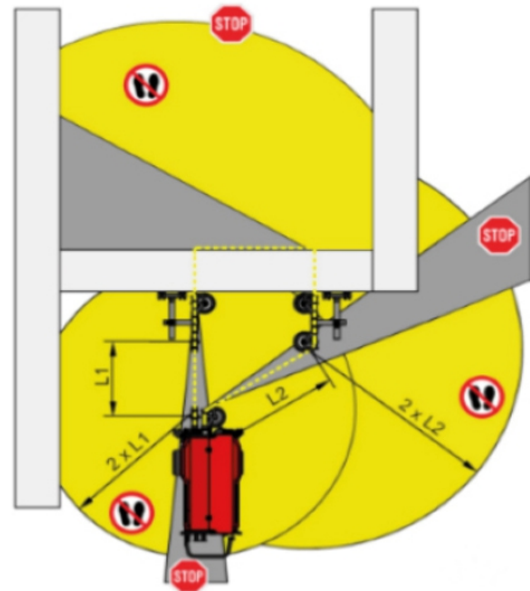

2.5.2 Danger zone A (shown here colored yellow)

Protection against whipping diamond wire.

In principle, you must assume that the diamond wire can break at any point. If this happens, the free ends of the wire can be deflected in any direction at the next relay point (in the direction of pull) of the sawing wire.

Notes for safe working practice:

- Keep a safe distance in all directions away from the relay points. The safe distance should be at least twice the radius of the length of sawing wire that can whip free in the event of a wire break.
- Invariably, work only when wire guides are mounted on the object to be cut. This precaution reduces the length of wire that can whip free and makes the danger zone considerably smaller.
- Avoid presence in the danger zones! Make sure that no-one enters the danger zones!

2.5.3 Danger zone B (shown here colored gray)

Protection against flying fragments.

In regular operation and in the event of a wire break, parts (e.g. fragments splintered off the structure or shattered cutting beads from the wire) can be flung out at high energy in the diamond wire's direction of pull. In principle, this is a risk that originates from every free length of wire. The danger zones, therefore, consist of additional corridors that extend in the direction of pull along the free lengths of sawing wire and beyond.

Notes for safe working practice:

- Unless additional safety measures such as protective paneling, protective curtains or sawing-wire guards are installed to stop flying fragments, these corridors are unlimited in length.
- Whenever possible, use the tubular guards for exposed lengths of sawing wire.
- Never pass through the hazard corridors while the wire saw is in operation!

2.6 Requirements to be met by operating personnel

Only specialists who have received training in concrete cutting techniques are permitted to operate the wire saw. These persons must be completely familiar with the content of



these operating instructions and must have been trained by a **Hilti** specialist on the safe application of these instructions.

The operator in charge must be aware of the possible dangers and of his responsibility for safety, both with regard to himself and to others. The operator is responsible for securing the danger area by cordoning it off and taking protective measures (guards, etc.) as necessary.

National regulations and laws, as well as the operating instructions and the safety information applicable to the accessories used (e.g. sawing wire, fastening accessories, lifting equipment, compressor, etc.), must be taken into account in this respect.

3 Description

3.1 Product overviews

3.1.1 System components



- | | |
|--|---|
| ① DSW 1510-CA drive unit | ⑤ Water nozzles |
| ② Accessories case | ⑥ DST WRC-CA wireless remote control unit |
| ③ DST WRC-CA wireless remote control unit (case) | ⑦ Compressed-air hose |
| ④ Air compressor | ⑧ Water hoses |
| | ⑨ DSW-SPP 240 single-pulley stand |



3.1.2 DSW 1510-CA drive unit

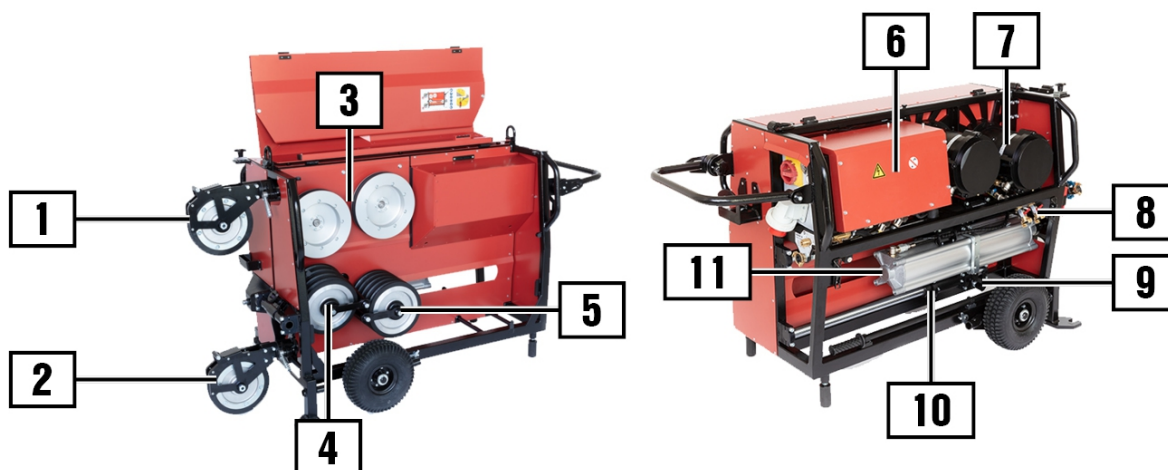

- | | |
|----------------------------------|---|
| ① Guide pulley (slack-wire side) | ⑦ Drive motors |
| ② Guide pulley (taut-wire side) | ⑧ Connections, water supply for water nozzles |
| ③ Drive pulleys | ⑨ Starting lock |
| ④ Wire storage pulleys (fixed) | ⑩ Compressed-air cylinder guide |
| ⑤ Wire storage pulleys (movable) | ⑪ Compressed-air cylinder |
| ⑥ Box for electrical components | |

3.1.3 Transport devices

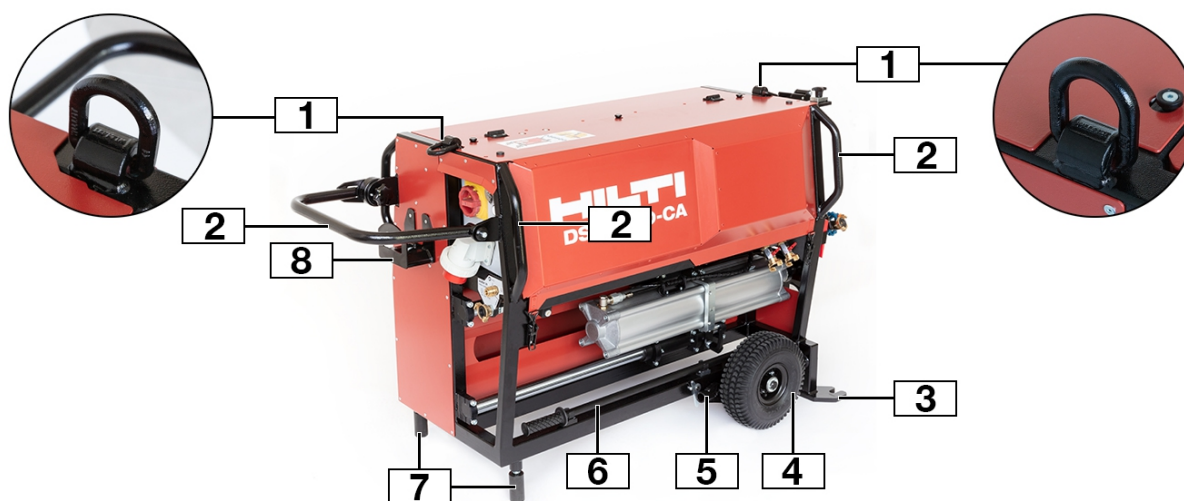

- | | |
|---|---|
| ① Lifting eyes | ⑤ Socket for lifting bar |
| ② Transport handle (adjustable) | ⑥ Lifting bar |
| ③ Feet (anchoring) | ⑦ Feet (leveling) |
| ④ Transport wheel with swivel mechanism | ⑧ Transport holder for DST WRC-CA wireless remote control |



3.1.4 Operating panel

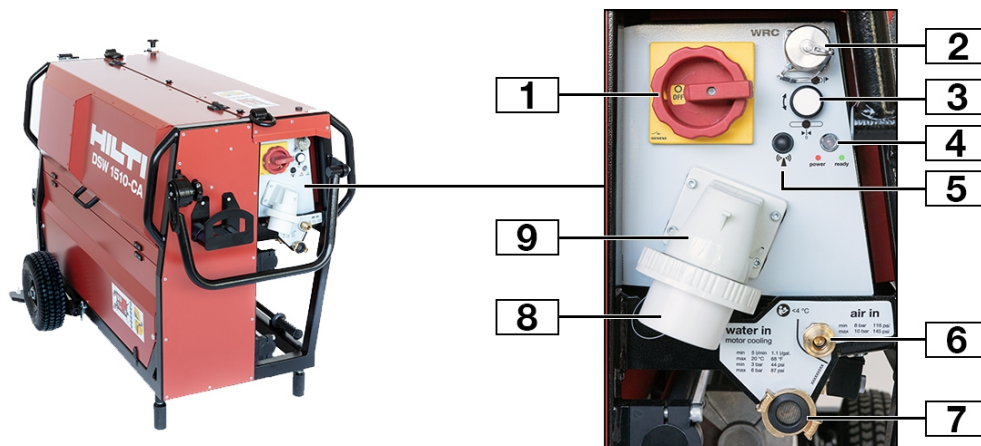

- | | |
|---------------------------------------|-----------------------------------|
| ① Main switch | ⑤ Antenna |
| ② Connection for remote control cable | ⑥ Connection, compressed-air hose |
| ③ 'Wire tension' operating button | ⑦ Connection, main water supply |
| ④ LED light | ⑧ Guard (electricity connection) |
| | ⑨ Connection, power supply |

3.1.5 DSW-SPP 240 pulley stand

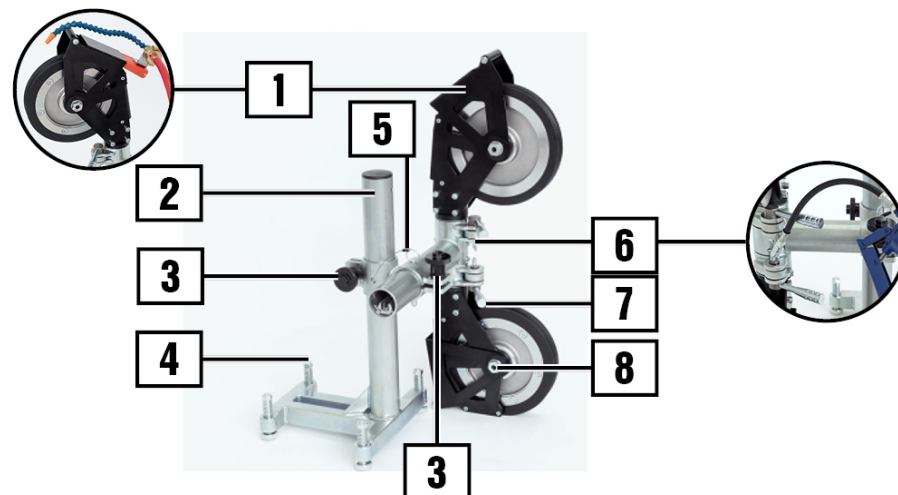

- | | |
|--|--|
| ① Pulley cover with adapter for cooling water spray nozzle | ⑤ Anti-twist locking pin |
| ② Pulley stand | ⑥ Grease nipple |
| ③ Clamping screw (for adjustment of wire guide unit) | ⑦ Clamping lever (for adjustment of guide pulleys) |
| ④ Leveling screws | ⑧ Guide-pulley axle with mounting adapter (protective tubes) |

3.2 Intended use

The product described is an electro-pneumatic wire saw with integrated wire storage unit. The product is designed for the technical demolition of steel, concrete, stone or brickwork structures in construction and civil engineering applications. The recommended working mode is wet cutting, in which the diamond wire is cooled by water and the dust is bound by water.

Dry cutting necessitates the use of diamond wires intended specifically for the application, along with additional protective devices to protect people and the environment from dust.



Only specialists who have received training in concrete cutting techniques, designated "users" below, are permitted to operate the wire saw. These persons must be completely familiar with the content of these operating instructions and must have been trained in safe operation by a **Hilti** specialist.

The user in charge must be aware of the possible dangers and of his responsibility for safety, both with regard to himself and to others.

3.3 Items supplied

Drive unit, air compressor, 2 single-pulley stands, case with accessories and tools, 2 water nozzles, compressed-air hoses, water hoses, operating instructions



The DST WRC-CA remote control is provided as a separate item.

Other system products approved for use with this product can be found at your local **Hilti Store** or at: www.hilti.group

3.4 Stickers on the product

The stickers on the product are as follows:

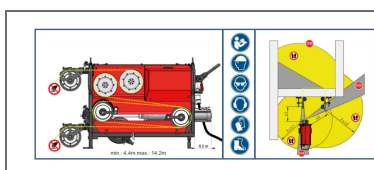

Schematic: Diamond wire routing
Danger zones when the wire saw is in operation

3.5 Operating principle

The wire is driven by two electric motors fitted with drive pulleys. The diamond wire is looped round the two drive pulleys and the wire storage pulleys in the drive unit. Via the guide pulleys at the face of the drive unit, the diamond wire is carried to the pulley stands at the structure or element to be cut, and back to the drive unit.

Wire tension is applied by the pneumatic cylinder.

The wire advance mechanism works like a block and tackle system, but in reverse. The advance movement, causing the wire to be drawn in, is achieved by pushing two pulley stacks apart. The maximum wire storage capacity is 14.2 m. The minimum length of wire contained in the drive system is 4.4 m.

Wire configuration in the drive unit

Wire configuration	Wire length (min.)	Wire length (max.)	Recommended start-up pressure
2nd level	4.4 m	6.8 m	20%
3rd level	5.7 m	9.3 m	25%
4th level	7.0 m	11.8 m	30%
5th level	8.2 m	14.2 m	35%

Wire storage capacity

Min. wire storage capacity in drive unit	4.4 m
Max. wire storage capacity in drive unit	14.2 m
Net wire storage capacity	9.8 m



4 Technical data

4.1 DSW 1510-CA drive unit

Dimensions (L x W x H)	1,620 mm x 785 mm x 980 mm
Weight	345 kg
Drive power (total)	16 kW
Engine speed	200 /min ... 1,980 /min
Cutting speed	3 m/s ... 28 m/s
Diameter (drive pulley)	280 mm
Diameter (guide pulley)	240 mm
Protection class in accordance with IEC 60529	IP 54
Ambient temperature (operation)	-10 °C ... 45 °C
Ambient temperature (storage)	-15 °C ... 50 °C
Wire storage capacity	9.8 m
Diameter (diamond wire)	8 mm ... 12 mm

4.2 Water supply

Length, water hose (cooling water jets)	10 m
Cooling water temperature	4 °C ... 20 °C
Minimum / maximum cooling water pressure	2 bar ... 6 bar
Min. cooling water flow rate (20 °C)	5 ℓ/min

4.3 Air compressor

Compressed air	8 bar ... 10 bar
Length, compressed-air hose	10 m
Air volume	100 ℓ/min
Power supply	230 V

4.4 DST WRC-CA wireless remote control unit

Weight in accordance with EPTA Procedure-01	1.6 kg
Range	20 m
Frequency band	2,400 MHz ... 2,483.5 MHz
Maximum emitted transmission power	10.9 dBm

4.5 Noise emission values

Sound (power) level	111 dB(A)
Sound pressure level	79 dB(A)
Uncertainty for the sound power level	3 dB(A)



4.6 DSW-SPP 240 single-pulley stand

Weight	18 kg + 9 kg
Dimensions (L x W x H)	400 mm x 400 mm x 800 mm
Minimum sizing of anchor (Uncracked concrete)	HKD M16x65

5 Tools and accessories

5.1 DS-W diamond wires







The use of high-grade diamond wires and connectors matched to the application and the wire saw is essential for safe and economical operation. Diamond wires of various specifications and types are available.

 Use only wire connectors and accessories specially matched to the applicable type of sawing wire. Follow the manufacturer's instructions when fitting and using these items.

The wire saw is designed for use with diamond wires in the 8 mm to 12 mm diameter range. At special request, the product can be configured by the manufacturer for use with thicker diamond wires.

For more information visit www.hilti.group or contact your **Hilti** specialist for diamond cutting equipment.

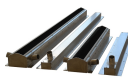
5.2 Accessories for diamond wire saws

Accessories	Designation	Description	Material number
	Single-pulley stand DSW-SPP	Guides the diamond wire from the drive unit to the structure to be cut.	2205152
	Release pulley DS-WSRW	At the start of a new cut, reduces friction at the edges.	315834
	Plunge wheel DSW-PW	Permits a plunging initial cut (plunge cut) whenever there is no access to the rear of the structure.	365428
	Plunge wheel (pivoting) DSW-PW	Permits cutting of the bottom, final section after cutting with the plunge wheel.	247620
	Guards DSW-WG 250	Reduces the risk of injury at exposed runs of the diamond wire.	2205155
	Dust cover DSW-DH 1.1-2.0	Reduces the quantity of dust produced, for example when dry cutting.	2012573
	Vertical-cut rig DSW-PW1510-CA	Permits cutting of columns and beams.	2301713
	Hilti tools set	Contains anchor-setting tools and accessories.	2048470 2048471 (US)



5.3 Accessories and wear parts for the wire saw system

i Hilti approved wear parts and other accessories for your product can be found in your local **Hilti Store** or at: www.hilti.group

6 Preparations at the workplace

6.1 Planning and safety

6.1.1 Planning the cuts to be made

Ask the site engineer or architect for confirmation of the exact position of the cuts to be made and make sure that any pipes, conduits or tensioning cables etc. that are to be cut through do not present any risks or hazards.

Bear in mind that the parts cut away might have to be divided into smaller, more easily manageable sections for removal and transport (i.e. on account of permissible floor loads, loading capacity of lifting equipment, size of door openings, etc.).

6.1.2 Planning wire guidance and sequence of cuts

Thorough training and experience are the most important prerequisites for optimum planning of the sequence of cuts and wire guidance system.

Do not exceed the system's performance rating when planning the length of the cut. Avoid cutting in a very flat arc (slow rate of progress) and in over-tightly radiused arcs and do not try to turn the diamond wire at a sharp angle (possibility of damaging the diamond wire). Arrange the cutting sequence so that the diamond wire cannot become trapped by parts that are cut away.

- ▶ Plan the sequence of operations before setting up the system.
- ▶ Plan the cooling water supply system and water disposal system.
- ▶ Observe the safety instructions.
- ▶ Define the danger zone. Cordon off the danger zone with barriers and adopt appropriate safety measures.
- ▶ Plan how the section to be cut away is to be secured, removed and transported away and prepare measures for these steps.
- ▶ Mark the cutting lines. If the section to be removed is large, cut it away in smaller parts if necessary.

6.1.3 Safety aspects to be clarified prior to installation

- ▶ Is the cutting area free from hazardous pipes or cables (gas, water, electricity, etc.)?
- ▶ Have the effects of the cutting work on the stability of the structure been clarified and are all supports capable of taking up the resulting loads?
- ▶ Can the possibility of hazards or damage as a result of the cooling water used be ruled out?
- ▶ Can the work zone be secured to such an extent that persons cannot be injured or property damaged by falling or flying parts?
- ▶ Can the parts of the structure cut away be removed safely in a controlled operation and disposed of?
- ▶ Do the electricity supply and the water supply available for use meet the specified requirements?
- ▶ Is the required equipment in the correct specification available for use?
- ▶ Has the work to be carried out been approved in full by site management?



6.2 Examples of wire guidance

The following examples illustrate the most common applications.

i Adhere to the examples shown in these operating instructions when positioning the wire guidance system and the pulley stands. Consult a wire sawing specialist about other wire guidance configurations.

For the sake of clarity, the wire guidance systems in the following examples are shown without guards fitted.

Examples of applications:

<p>Straight cut, good for longevity of diamond wires</p>		
<p>Vertical cut (release pulley) Fast cutting process with high load and lesser longevity of diamond wires</p>		
<p>Horizontal cut</p>		
<p>Doorway cut, right</p>		



<p>Doorway cut, bottom</p>	
<p>Doorway cut, top</p>	
<p>Doorway cut, left</p>	
<p>Column cut using the horizontal/vertical sawing device</p>	
<p>Beam cut with horizontal/vertical device</p>	



Plunge cut
Bottom cut with plunge cut device using the plunge pulley accessory

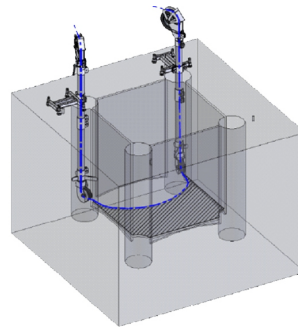

6.3 Determination of storage capacity needed and necessary wire length

Key:

- **y** : Wire length (taut wire side)
- **x** : Wire length (slack wire side)
- **z** : Length of cut
- **D** : Thickness (object to be cut)

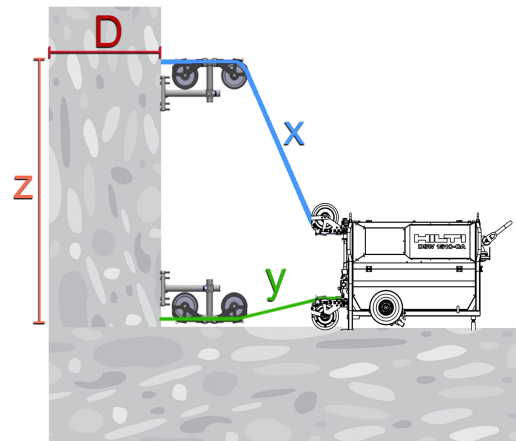

Approximate calculations

Required wire storage capacity	Wire length
$D \times 2$	$4.4 + x + y + z + D \times 2$

6.4 Power supply and fuse rating

Make sure that the site-provided electricity supply, regardless of whether it is from the electricity grid or from a generator, incorporates a ground conductor and ground fault circuit interrupter and that these components are correctly connected.

Check that the fuse rating of the electric power supply at the construction site is as follows:

3 x 400 V voltage

Fuse rating	32 A
Residual current device (RCD) type A or type B	30 mA

i It is not permissible to tamper with or replace the electricity supply plug. If necessary, have a trained electrical specialist alter your extension cord by fitting the electric socket supplied.

Wiring diagram for CEE power outlet (3 x 400 V, 32 A)

	L1	Phase 1
	L2	Phase 2
	L3	Phase 3
	N	Neutral conductor
	PE	Protective conductor (ground)



i The wire saw will run even if the electricity supply has only 4 conductors (3 phases and 1 ground).

6.5 Use of extension cables

WARNING

A damaged supply cord presents a hazard! Do not touch the supply cord or extension cord if damaged while working. Disconnect the supply cord plug from the power outlet.

- ▶ Check the appliance's supply cord at regular intervals and have it replaced by a qualified specialist if found to be damaged.
- ▶ Use only extension cables of a type approved for the application and with conductors of adequate gauge (cross section). The machine may otherwise suffer a drop in performance and the extension cable may overheat.
- ▶ Check to ensure that an extension cable is fully unrolled before the saw is put into operation.
- ▶ Check the extension cable for damage at regular intervals.
- ▶ Replace damaged extension cables.
- ▶ When working outdoors, use only extension cables that are approved and correspondingly marked for this application.

Minimum conductor cross section (gauge) for extension cables

	Extension cable length			
	≤ 50 m	> 50 m and ≤ 75 m	> 75 m and ≤ 135 m	> 135 m and ≤ 200 m
Minimum conductor cross section (gauge)	4 mm ²	6 mm ²	10 mm ²	16 mm ²
* The figures apply at an ambient temperature of below 30 °C.				

6.6 Requirements to be met by the cooling water supply

- ▶ At cooling-water temperature of 20 °C, a flow rate of approx. 5 l/min is required to cool the drive.
 - ▶ The wire saw's automatic shutdown trips if cooling is inadequate.
- ▶ Use only clean water. Do not use salty water (such as seawater, for example).
- ▶ Where pressure in the water supply line is low, a non-return valve should be fitted in order to prevent dirty water finding its way into the water supply.
- ▶ Use a pressure reduction valve if the line pressure is too high (above 6 bar).

7 Before use

7.1 Location and connections

7.1.1 Requirements to be met by the set-up location

A basic prerequisite for safe and efficient use of the saw system is that it must be secured using a means of fastening suitable for the applicable material and of adequate dimensions. Set up the drive unit only on a flat and level surface.

The drive unit can shift in the direction of the tension on the wire if the wire jams while sawing is in progress. Use anchors at the supporting feet or a ratchet strap to prevent inadvertent movement of the drive unit. Whenever possible, set up the drive unit in such a way that the lengths of wire released by a wire breakage are as short as possible.



Correct and incorrect set-up of the drive unit

Consider the following requirements when you evaluate the suitability of the site for positioning the drive unit:

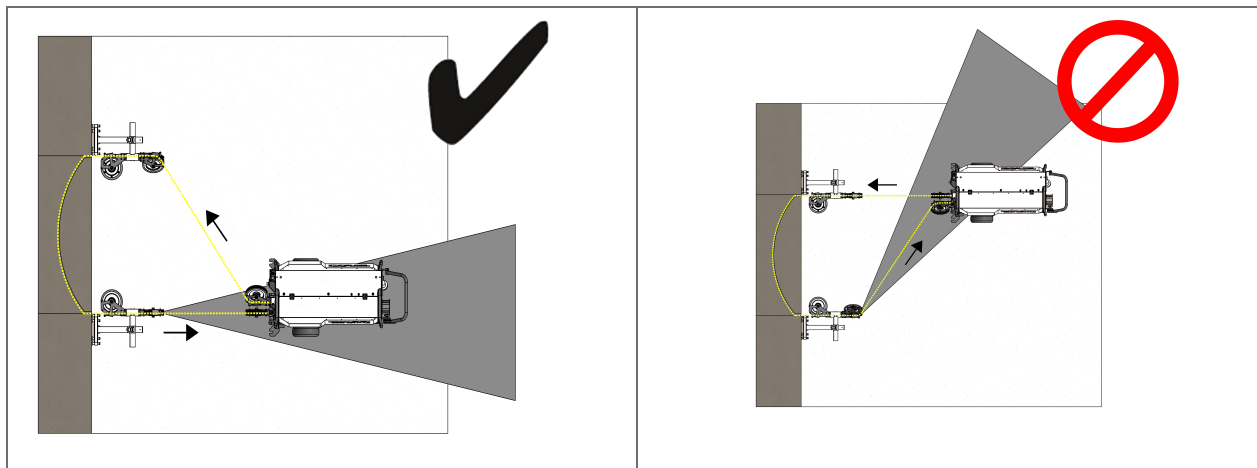

7.1.2 Setting up drive unit

WARNING

Risk of injury! Risk of injury if the pulley stand falls!

- ▶ Use only anchors suitable for the base material to secure the pulley stands. Comply with the instructions for use in the operating instructions of the anchor.



In principle, the **Hilti** HKD M16 metal expansion anchor is suitable for setting as anchor in concrete to secure the equipment. An alternative method of attachment might be necessary however, depending on circumstances.

ATTENTION! The HKD M16 is not suitable for use in cracked concrete, masonry, man-made or natural stone and similar materials.

Contact **Hilti** Technical Service if you have questions about secure fastening.

1. Transport the drive unit to the desired position. → page 34
2. Use the lifting bar to retract both wheels.
3. Adjust the feet (leveling) to level the drive unit so that it is firm and steady.
4. Secure the drive unit with anchors at the feet (anchoring), or with ratchet straps, so that it cannot slip.

7.1.3 Drilling through-holes for wire guidance



When sawing through very thick objects, cut the part to be removed at slight angle to form a taper. This will make the part easier to remove after it has been cut out.

1. Check the positions of the through-holes.
2. Use a rig-based diamond core drilling machine to drill the through-holes.



- When walls are thinner or permissible tolerances large, the through-holes can also be drilled with a rotary hammer drill.
- Minimum hole diameter: **thickness (diamond wire) x 1.5.**

3. Round the corners of the edges of the drilled holes by using a suitable tool



7.1.4 Fastening a pulley stand

i In principle, **Hilti** M16 metal expansion anchors are suitable for setting as anchors in uncracked concrete to secure the equipment. An alternative method of attachment might be necessary however, depending on circumstances. Contact **Hilti** Technical Service if you have questions about secure fastening.

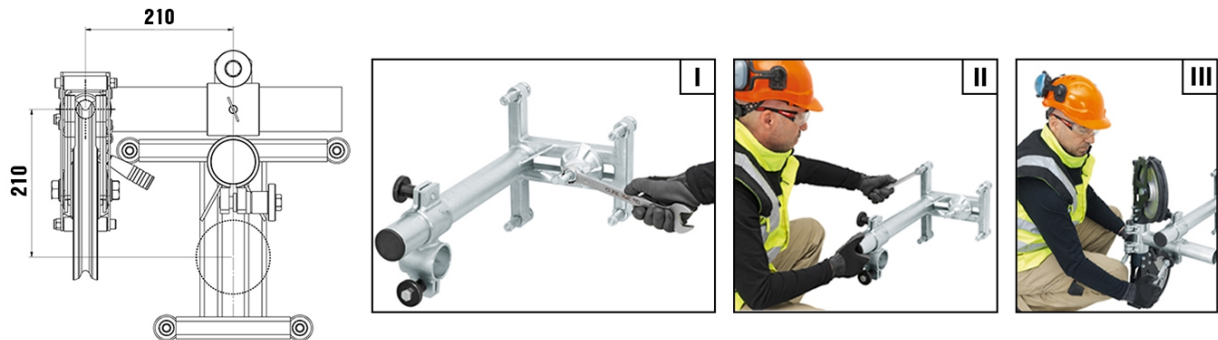

WARNING

Risk of injury! Risk of injury if the pulley stand falls!

► Use only anchors suitable for the base material to secure the pulley stands. Comply with the instructions for use in the operating instructions of the anchor.

1. Mark the position of the anchor hole for the pulley stand.
2. Drill the anchor hole and clean it out.
3. Insert the anchor in the hole and use the setting tool to expand the anchor.
4. Screw in the clamping spindle as far as it will go and then back off the clamping spindle 1 full turn.
5. Fully back off the 4 leveling screws on the pulley stand.
6. Set the pulley stand on the clamping spindle and bring it into correct alignment.
7. Screw the clamping nut on to the clamping spindle and tighten it firmly with an open-ended wrench **(I)**.
8. Tighten the leveling screws evenly until the pulley stand is upright and firmly seated on the surface **(II)**.
9. Position the wire guide unit with clamp on the stand and bring the wire guide unit into correct alignment.
10. Tighten the clamping screw for the wire guide unit firmly with an open-ended wrench **(III)**.

7.1.5 Connecting the electricity supply, water and compressed air

Make sure that the main switch is set to **OFF** and that the **EMERGENCY STOP** button has been pressed.

i The cooling-water valves are open when the drive unit is switched off. If you want to interrupt the flow of cooling water with the drive unit switched off, close the cooling-water valves by hand.



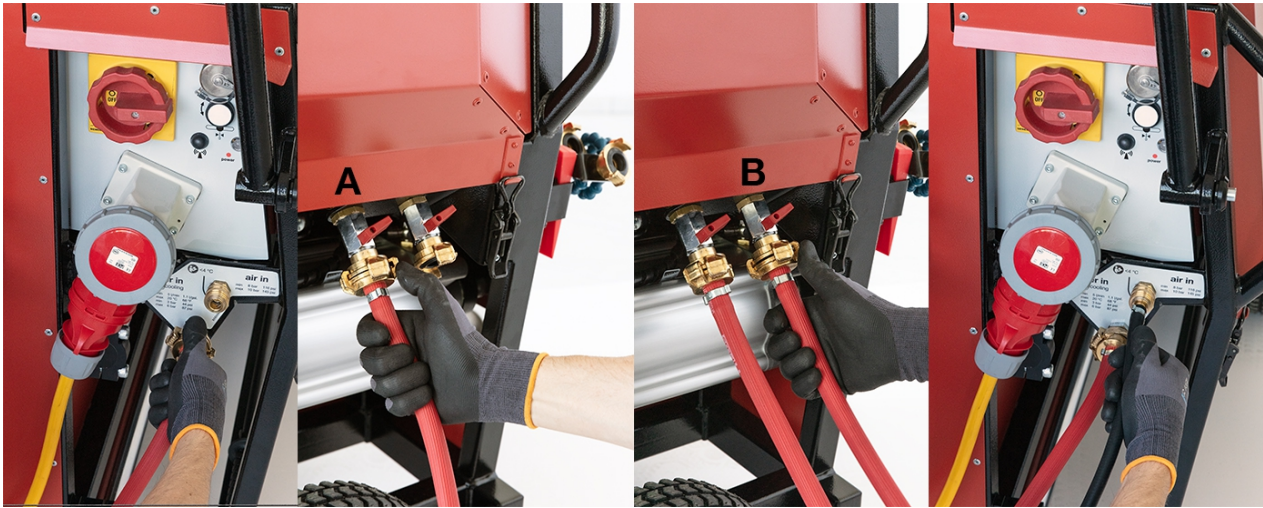

1. Set up the drive unit on the jobsite. → page 22
2. Connect a cooling-water hose to the inlet on the drive unit and to an outlet of the on-site water supply.
3. Connect both cooling-water hoses to distributors **(A)** and **(B)**.
4. Route the cooling-water hoses to the cutting location and connect the cooling water hoses to the flexible cooling-water spray nozzles.
5. Open the water valves at the distributors.
6. Open the on-site water supply.

i Water can flow through, because the main switch is set to **OFF**.

7. Position the compressor in the vicinity of the drive unit.
 - ▶ The compressor is positioned where it cannot get wet.
8. Connect the compressed-air hose to the compressor and to the drive unit.
9. Establish an electricity supply and switch the compressor on.
 - ▶ Comply with the instructions for use in the operating instructions of the compressor (max. 10 bar).
10. Remove the guard from the electricity connector by turning the locking sleeve counter-clockwise to disengage it.
11. Using a suitable power cord, connect the drive unit to the power source.

7.2 Pairing DST WRC-CA wireless remote control

i The drive unit has to be connected to the electricity supply in order for it to be paired to the DST WRC-CA wireless remote control.

1. Remove the protective cap from the connector on the drive unit.
2. Plug the remote control back up cable into the socket and tighten the securing sleeve.
 - ▶ An audible click confirms correct latching.
3. Plug the remote control back up cable into the socket of the wireless remote control.
4. Set the main power switch of the drive unit to **ON**.
5. Set the main power switch on the remote control to **ON**.
6. Follow the installation instructions displayed on the screen.
7. Refer to the corresponding chapter **wire saw** mode in the operating instructions DST WRC-CA remote control.



7.3 Diamond wire

7.3.1 Fitting wire connectors and connection of diamond wire

i Read and follow the instructions given in the operating instructions of the diamond wire and the connectors.

7.3.2 Diamond-wire path and cutting direction

The illustration shows the path of the diamond wire through the structure and the drive unit in the cutting direction.

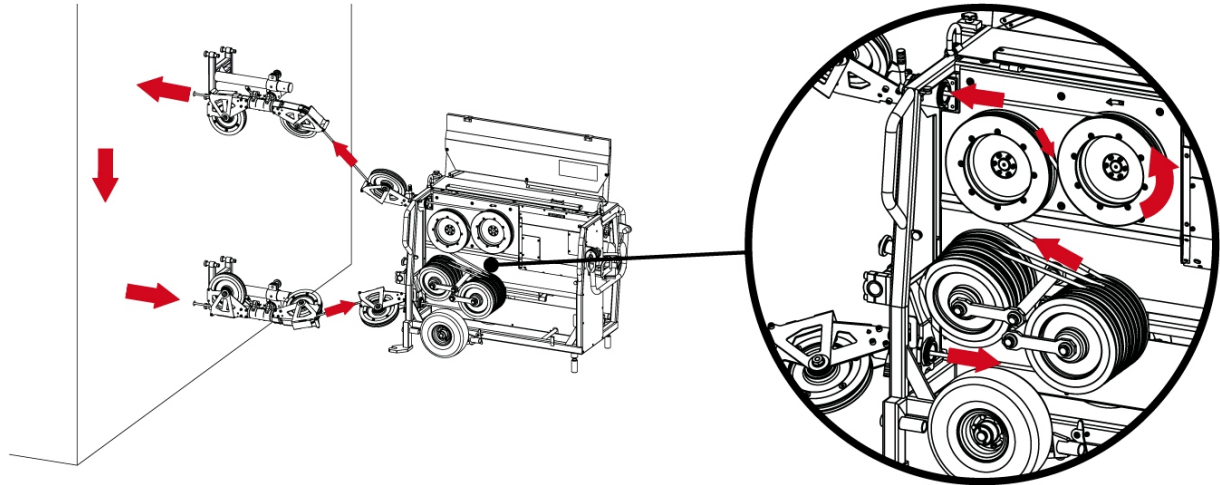

i Use the guide pulleys to control the diamond wire and restrict the free lengths of the diamond wire to a minimum.

The length and height of the wire arc influence the rate of progress and the service life of the diamond wire.

Note the cutting-direction indicator on the diamond wire. You can also identify the cutting direction by the conical shape of the cutting beads. The small-diameter end of the beads always faces in the cutting direction.

7.3.3 Laying diamond wire on to pulleys

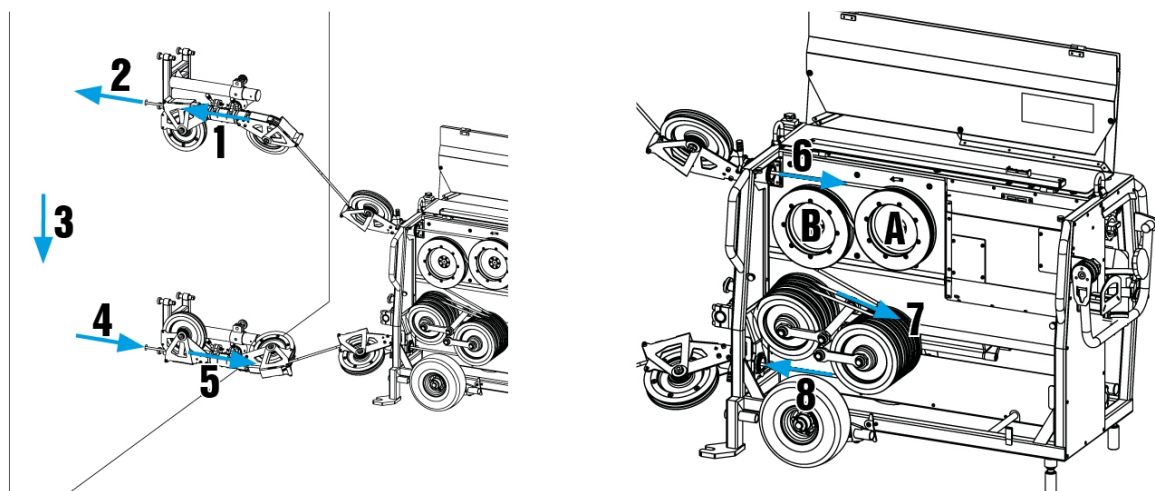

1. Before entering the danger zone, always press the **EMERGENCY STOP** button or the **ON/OFF** switch on the remote control unit.
2. Feed the diamond wire through the hollow axle of the pulley stand (slack-wire side) (1).
3. Feed the diamond wire through the first through-hole drilled in the structure (2).



4. From the rear of the structure, feed the diamond wire back through the second hole **(3)**.
5. Feed the diamond wire through the hollow axle of the pulley stand (taut-wire side) **(4)**.
6. Open the cover of the drive unit.
7. Feed the diamond wire through the hollow axle of the guide pulley (slack-wire side) **(6)**.
8. Loop the diamond wire clockwise round the drive pulley **(A)**.
9. Loop the diamond wire counter-clockwise round the second drive pulley **(B)**.
 - ▶ The diamond wire is looped in an S shape round the drive pulleys.
10. Loop the diamond wire round the pulleys on the storage levels necessary for the length of the wire **(7)**.



Be sure to lay the wire round the pulleys in the correct sequence!

To allow full use of the wire storage capacity, set up the drive unit so that if possible, only the first wire storage level has to be occupied initially.

- Too much diamond wire left over → Shorten the diamond wire or position the drive unit further from the structure.
- Too little diamond wire left over → Use a longer diamond wire or position the drive unit closer to the structure.

11. Feed the diamond wire through the hollow axle of the guide pulley (taut-wire side) **(8)**.
12. Twist the diamond wire counter-clockwise 1 to 1.5 turns per running meter.



Twisted in this way, the diamond wire wears evenly.

You can make the wire easier to twist by tying a loop at the end of the wire and using the loop as a twisting aid.

13. Connect the ends of the wire with a wire connector.
 - ▶ Comply with the manufacturer's specifications and installation instructions!
14. Slacken the clamping screw of the guide pulley (taut-wire side) and bring the guide pulley into alignment with the diamond wire.
 - ▶ The marking grooves indicate the positions of the wire-storage levels and facilitate alignment.
15. Check that the wire is correctly seated in the grooves of the drive pulleys, wire storage pulleys and guide pulleys.
16. (Work step requiring two persons) Check the ease of movement of the diamond wire by pulling the diamond wire back and forth by hand.
 - ▶ The diamond wire is easy to move → the edges of the through-hole are sufficiently rounded!
 - ▶ The diamond wire is difficult to move → round off the edges of the through-hole some more!

7.3.4 Check of diamond wire / guide pulley alignment (slack-wire side)



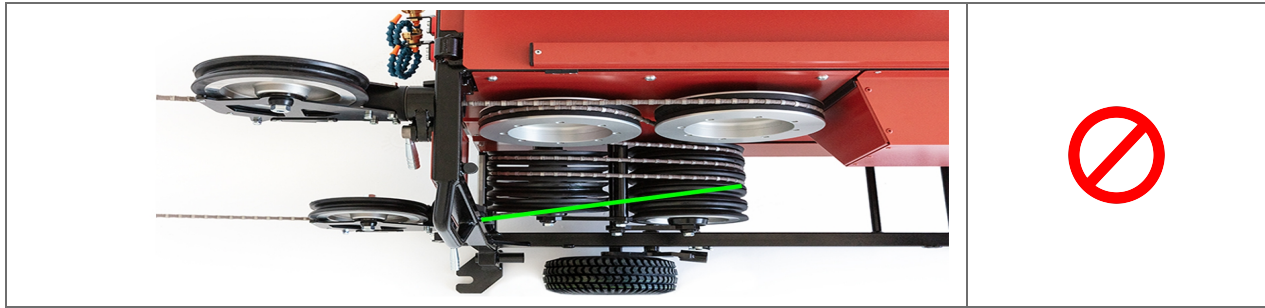

7.3.5 Tensioning diamond wire

1. Lay the diamond wire on the drive pulleys and the pulleys of the wire storage unit.
→ page 25
2. Set the main switch to **ON**.
3. Switch the air compressor on.
4. Tension the diamond wire by pressing the **Wire tension** operating button on the drive unit.
5. Align all the guide pulleys of the drive unit with the drive pulleys of the pulley stands.
6. Check that the wire is centered in the grooves of the drive pulleys, wire storage pulleys and guide pulleys.
7. Check the entire routing of the wire.
8. Push the starting lock all the way towards the pneumatic cylinder and clamp the starting lock securely in position.

7.3.6 Setting up cooling of the diamond wire

i The motors must be cooled even when the dry cutting technique is used. Use a closed water circuit and pipe the discharged water to a drain or reservoir.
It might be necessary to re-adjust the water spray nozzles as sawing progresses.

1. Connect the water supply to the water spray nozzles.
2. Connect the water supply to the connections on the drive unit.
3. Place the cooling water nozzle (front of object to be cut).
4. Aim the nozzle at the diamond wire's point of entry into the object to be cut.
 - ▶ The cooling water has to be carried into the through-hole by the diamond wire.
5. Place the cooling water nozzles (rear of object to be cut).
6. Aim the nozzle at the diamond wire's point of entry into the object to be cut.
 - ▶ The cooling water has to be carried into the through-hole by the diamond wire.

7.3.7 Fitting the guards

i Enter the danger zone only when the **EMERGENCY STOP** button or the ON/OFF switch on the remote control unit has been pressed to stop the machine.
Always use the wire guards whenever possible; this increases safety on the jobsite.



- ▶ Comply with the instructions for installation in the operating instructions of the guards.



8 Operation

8.1 Checks before beginning sawing

Before starting operations with the wire saw, clarify the following safety aspects:

- ▶ Has the danger area been correctly defined and has it been ensured that these areas are not entered during operation?
- ▶ Are the guards correctly installed?
- ▶ Have the necessary supports and covers been installed correctly?
- ▶ Have the individual pieces of equipment been installed with adequate security?
- ▶ Has the diamond wire been installed in the correct direction of travel and can it be pulled back and forth easily by hand in the cut?
- ▶ Are the guide pulleys in correct alignment with the diamond wire?
- ▶ Does the feed cylinder have enough remaining stroke and is the start lock set correctly?
- ▶ Have the electric cables, water and compressed air hoses been connected correctly, safely routed and locked?
- ▶ Have the water nozzles been positioned correctly? (The water should be carried into the cut by the wire.)
- ▶ Do the electric power and water connections meet the necessary requirements?

8.2 Starting drive unit and beginning sawing

i The following preconditions must be satisfied before you start the sawing operation:

- ✓ The main switch of the drive unit and the wireless remote control is set to **ON**.
- ✓ The indicator lamp on the drive unit and the wireless remote control shows green.
- ✓ The compressed-air system is connected and is pressurized.
- ✓ The water supply is connected and filled with cooling water.

1. Set the main switch to **ON**.
2. Switch the DST WRC-CA wireless remote control unit on.
3. Exit the danger zone.
4. Disengage the **EMERGENCY STOP** button on the wireless remote control.
5. Confirm your identification with the wireless remote control.
6. Select the current wire storage level.
 - ▶ The storage level corresponds to the number of wire-storage pulley pairs occupied by wire lays.
7. Accept the proposed values for speed and pressure or adapt the values as appropriate.
8. Press the start button on the wireless remote control and hold it down for 3 seconds.
 - ▶ The drive starts.
 - ▶ The water supply is switched on.

i For more detailed information about settings and operation, see the operating instructions for the DST WRC-CA wireless remote control.



8.3 During operation of the wire saw

DANGER

Serious injury hazard! Risk of injury due to entry into the danger zone or unforeseen situations.

- ▶ Press the **EMERGENCY STOP** button immediately if a dangerous, unforeseen or critical situation arises (e.g. if the diamond wire jumps off a guide pulley or if a person enters the danger zone).
- ▶ Before entering the danger zone, always press the **EMERGENCY STOP** button or the **ON/OFF** switch on the remote control unit.

While the saw is in operation keep well clear of the danger zone and monitor:

- Danger zone
- Wire guidance and possible vibrations
- Cutting parameters (current input, advance pressure and wire speed) on the display
- Water cooling at the diamond wire

if the diamond wire vibrates excessively during operation, check the alignment of the guide pulleys and, if necessary, change wire speed and advance pressure.

Toward the end of the cut the arc followed by the wire becomes flatter, with corresponding reductions in the diamond wire's contact pressure and cutting performance. If necessary, compensate this by increasing advance pressure or by adjusting wire guidance so that the wire cuts in a tighter arc.

Cutting speed guide values (concrete)

Select an advance pressure level at which the current power level is in the range 80-100%.

Operating mode	Recommended cutting speed
Wet	20 m/s ... 28 m/s
Dry	10 m/s ... 15 m/s

Notes on cooling of the diamond wire

Operating mode	Cooling	Comment
Wet	approx. 5-8 liters of water per minute	Adjust the water spray nozzles if dust develops.
Dry	Air cooling The longer the diamond wire, the more effective air cooling will be.	Make sure that the diamond wire does not get too hot. If necessary, use a suitable dust extractor to cool the diamond wire.

8.4 Changing storage levels

When the cylinder reaches its maximum stroke the wire storage unit is full and you have to resume operation using the lay on a new wire storage level. The drive has a limit switch that stops the drive automatically when it is reached.

- Valve position (air compressor) remains at **Extend cylinder**.
- Water supply is shut off (if water supply is set to **AUTO** or **MANUAL**).

A message to this effect appears on the display of the DST WRC-CA wireless remote control.



1. Before entering the danger zone, always press the **EMERGENCY STOP** button or the **ON/OFF** switch on the remote control unit.
2. Open the cover of the drive unit.
3. Set the valve to the neutral position by pressing the **Wire tension** button on the drive unit.
4. Press the **Wire tension** button and hold it down until the compressed-air cylinder has reached neutral position.

i The cylinder continues to retract as long as you hold down the **Wire tension** operating button, or until it has fully retracted. As soon as you release the **Wire tension** operating button, the cylinder stops retracting and remains in its current position.

5. Lay the diamond wire round the next storage levels.
6. Adjust the position of the guide pulley (taut-wire side) to suit the new wire storage levels.
7. Press the **Wire tension** button to tension the wire.
8. Check that the wire is correctly seated in the grooves of the guide pulleys and wire storage pulleys.
9. Close the cover of the drive unit.
10. Exit the danger zone.
11. Disengage the **EMERGENCY STOP** button on the wireless remote control.
12. Set the current wire storage level on the wireless remote control.
13. Resume sawing. → page 28

8.5 Shutting down drive unit (interrupting sawing operation)

1. If the wire saw is in **AUTO** mode, use the wireless remote control to activate the  mode.
2. Reduce the speed.
3. Reduce the pressure.
4. Using the wireless remote control, shut off the water supply and the drive unit.

8.6 Shutting down drive unit (ending sawing operation)

1. If the wire saw is in **AUTO** mode, use the wireless remote control to activate the  mode.
2. Reduce the speed.
3. Reduce the pressure.
4. Switch off the motor.
 - ▶ Water supply is shut off (if water supply is on **AUTO**).
5. Before entering the danger zone, always press the **EMERGENCY STOP** button or the **ON/OFF** switch on the remote control unit.
6. Set the cylinder to neutral position by pressing the **Wire tension** button.
7. Set the main switch to **OFF**.
8. Find the wire connector and open it.
9. Remove the diamond wire from the drive.
10. Clean the drive unit and the pulley stands. → page 31
11. Set the wire storage pulleys to the transport position and secure the wire storage pulleys with a ratchet strap.
12. Remove the pulley stands.



9 Care and maintenance

WARNING

Electric shock hazard! Attempting care and maintenance with the supply cord connected to a power outlet can lead to severe injury and burns.

- ▶ Always unplug the supply cord before carrying out care and maintenance tasks.

Maintenance

WARNING

Danger of electric shock! Improper repairs to electrical components may lead to serious injuries including burns.

- ▶ Repairs to the electrical section of the tool or appliance may be carried out only by trained electrical specialists.
-
- Check all visible parts and controls for signs of damage at regular intervals and make sure that they all function correctly.
 - Do not operate the product if signs of damage are found or if parts malfunction. Have it repaired immediately by **Hilti Service**.
 - After cleaning and maintenance, fit all guards or protective devices and check that they function correctly.

To help ensure safe and reliable operation, use only genuine Hilti spare parts and consumables. Spare parts, consumables and accessories approved by Hilti for use with the product can be found at your local **Hilti Store** or online at: www.hilti.group.

9.1 Cleaning drive unit

CAUTION

Electric shock hazard! Water entering the equipment can lead to life-threatening electric shocks.

- ▶ It is essential to disconnect the drive unit from the main electricity supply before starting cleaning work.

Follow these instructions for cleaning:

- Clean the drive unit with running water at low pressure (e.g. from a water hose).
 - Do not use running water to clean the wireless remote control unit, air compressor or plug connections.
 - If necessary, also clean the drive unit and the pulley stands between individual cutting operations. Do not wait too long before cleaning. The sawing slurry adhering to parts dries very quickly.
 - Every time you clean them, check the drive unit and pulley stands for signs of damage and check the freedom of movement of all moving parts. Have all damaged parts and parts that are not in full working order replaced immediately, to prevent accidents and consequential damage or injury.

1. Set the main switch to **OFF**.
2. Disconnect the supply cord plug from the main power supply.
3. Remove residues adhering to the housing.
4. Open the cover of the drive unit.
5. Clean the wire storage pulleys and drive pulleys.



6. Clean the pneumatic cylinder and guide unit.

9.2 Blow remaining traces of water out of the cooling water circuit and motors

i At temperatures below 4 °C (39 °F), the water in the cooling circuit has to be blown out with compressed air when work is interrupted for more than one hour and before the equipment is stowed away.

1. Disconnect the water supply and discharge hoses from the drive unit.
2. Open the water valves at the water distributors.
3. Blow through with compressed air at the water supply connection on the drive unit.
 - ▶ Blow compressed air into the drive until no more water comes out.

9.3 Carrying out maintenance

i Comply with the instructions for use in the operating instructions of the grease gun.

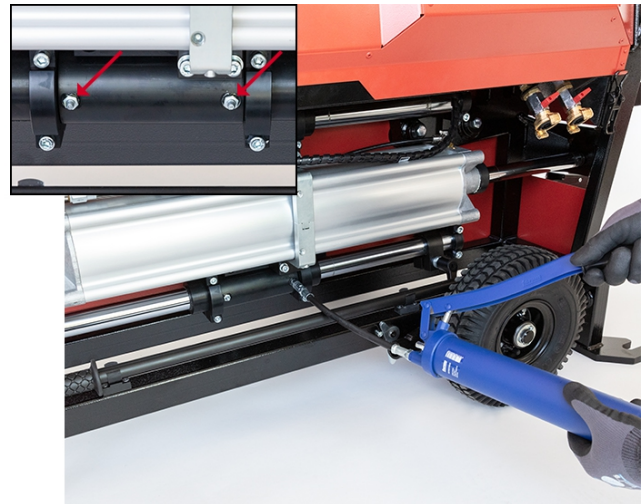
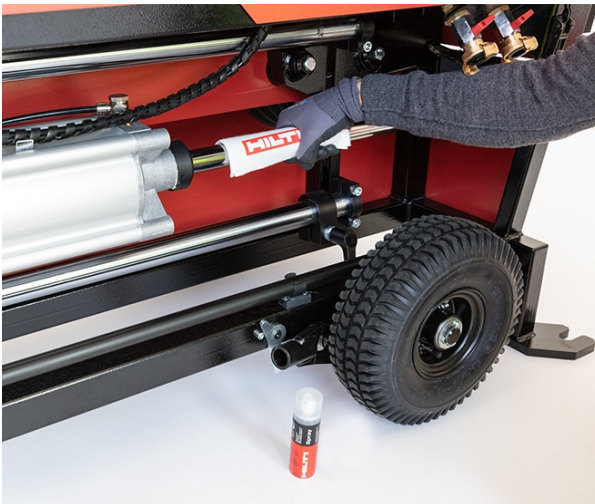

1. Position the compressed-air cylinder with the piston rod fully extended.
2. Clean the piston rods with a cloth and **Hilti** spray.
3. Move the piston to make sure that you also clean the areas of the piston rod covered by the guide bearings.
4. Connect the tube of the grease gun to the grease nipple.
5. Inject grease into the 2 grease nipples.

i Continue injecting grease until the grease squeezes out at the piston rods. In this way you clean the bearings.



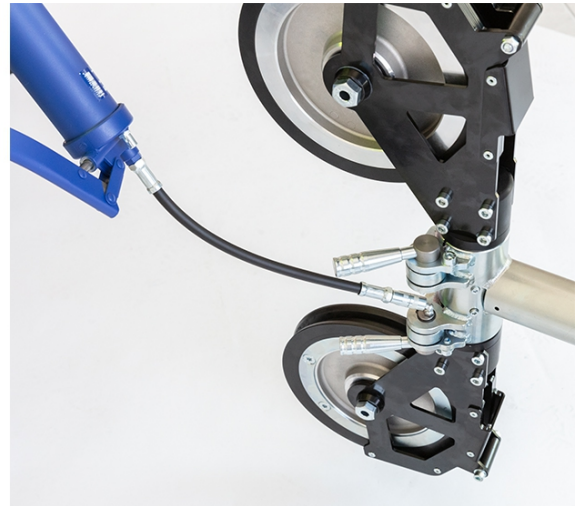

6. Lubricate the guide pulleys on the drive unit and the pulley stands.

9.4 Replacing rubber-tired pulleys on the DSW-SPP 240 single-pulley stand

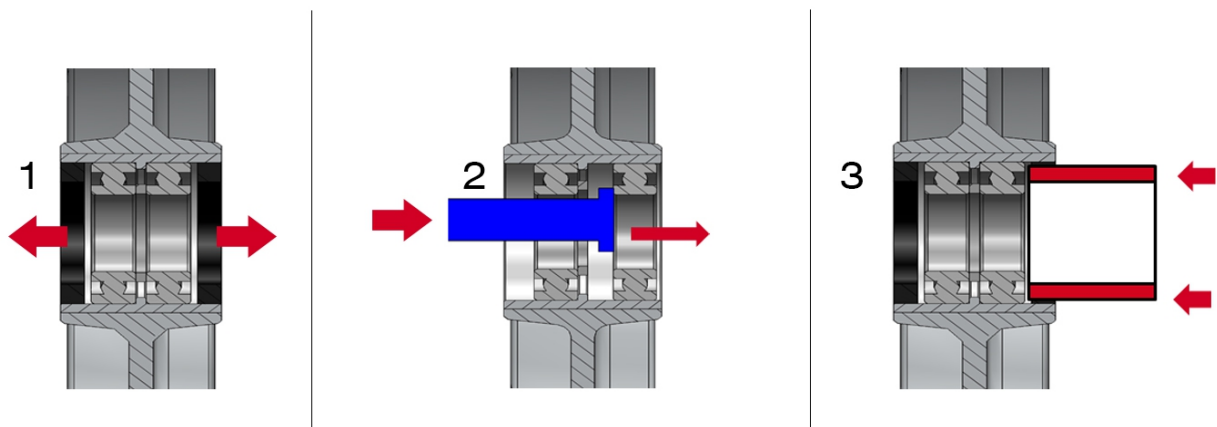

1. Remove the pulley.
2. Remove the worn sealing rings (2 of) **(1)**.
3. Remove the ball bearings by using a suitable tool to press out the ball bearings from the inside toward the outside **(2)**.
4. Press in the new ball bearings **(3)**.

i Before pressing them in, check each ball bearing to ensure that it is a correct fit. Seat the press-in tool only against the outside ring of the ball bearing .

5. Press in the new sealing rings.
6. Lubricate the sealing rings with grease.
7. Use a suitable screwdriver to slacken the screws (8 TX 45 screws) of the locating ring.
8. Remove the worn rubber tire.
9. Clean the contact faces of the tire carrier and the locating ring.
10. Install the new tire and the locating ring.
11. Use a suitable screwdriver to tighten the screws (8 TX 45 screws) of the locating ring to 25 Nm.
 - ▶ The pulley is serviced and ready for installation.



10 Transport and storage

Transport

- ▶ Use the grips provided for transportation. Keep the grips clean and free from oil and grease.
- ▶ Avoid lifting and carrying heavy loads. Use suitable lifting equipment and means of transport and, when necessary, share the weight of heavy items between several persons.
- ▶ Make sure that the equipment is held securely throughout all transport operations. Secure the machine and its components to prevent movement or falling over during transportation.
- ▶ Use only tested and approved lifting gear secured to the point provided for the purpose to transport the device by crane. Before lifting, check that all removable parts are secure, the drive unit is locked and the end stop installed. Never stand or pass beneath a suspended load.
- ▶ After transporting, always check all visible parts and controls for signs of damage and make sure that they all function correctly.

Storage

- ▶ Always store this product with the electric supply cable unplugged from the electricity supply.
- ▶ Bear in mind that the machine could fall over. Stand the machine only on a solid, level surface. Use the forward-facing pivoting pulleys to help steady the wire saw against a suitable surface.
- ▶ Store this product in a dry place, where it cannot be accessed by children or unauthorized persons.
- ▶ After a long period of storage, always check all visible parts and controls for signs of damage and make sure that they all function correctly.

10.1 Transporting drive unit

WARNING

Risk of injury! Unsecured drive unit can cause damage during transport.

- ▶ If you are going to transport the drive unit on a trailer or a transporter, flip the wheels up and secure the drive unit and the other components with ratchet straps.
-



Use suitable lifting equipment (e.g. fork-lift truck, crane) or a winch to load onto / unload from the vehicle or trailer.

Use the ratchet strap supplied with the equipment to secure the wire storage pulleys for transport.

For transport by crane, use the lifting eyes provided for the purpose.





1. Disengage the lock securing the transport handle.
2. Swing the transport handle into a horizontal position.
 - ▶ The teeth of the lock are securely intermeshed.
3. Tighten the lock of the transport handle.
4. Insert the lifting bar into the socket at the swivel mechanism.
5. Release the catch and use the bar to pivot the wheel down into position.
 - ▶ The catch is re-engaged.
6. Repeat these steps on the opposite side.
 - ▶ The drive unit is now ready for transport.

i Where access is awkward, the drive unit can also be maneuvered into position by two persons.



7. Hold the drive unit by the transport handles provided for the purpose.

11 Troubleshooting table

Trouble or fault	Possible cause	Action to be taken
The wire saw doesn't start.	Edges of the structure are too sharp.	<ul style="list-style-type: none"> ▶ Use a suitable tool to round off the edges of the structure and manually bed the sawing wire into the material to be cut.



Trouble or fault	Possible cause	Action to be taken
The wire saw doesn't start.	A new sawing wire jams in a kerf made by a worn sawing wire.	<ul style="list-style-type: none"> ▶ Complete the cut with the worn sawing wire or use a thinner sawing wire. ▶ Drill another hole that can be used to draw the new sawing wire into position.
	Sawing-wire-to-concrete contact length is excessive.	▶ Install more guide pulleys or release pulleys.
	Tension on the wire is too high.	▶ Reduce tension on the wire by adjusting the pneumatic control valve.
	Sawing wire installed wrong way round.	▶ Check the sawing wire is installed for the correct direction of travel.
	The wire is defective.	▶ Replace the sawing wire.
The drive pulley slips / the wire is not driven by the pulley.	Insufficient wire tension.	▶ Increase the wire tension.
	The drive pulley is too badly worn.	▶ Replace the drive pulley.
The wire jumps off the drive wheel or guide pulley when starting the saw.	The starting lock was not used.	▶ Use the starting lock (lock the sleeve directly at the air cylinder).
	Sawing wire installed wrong way round.	▶ Check the sawing wire is installed for the correct direction of travel.
Uneven / one-sided wear of the sawing wire.	The diamond wire was not twisted before connecting the ends together.	▶ For each meter of length, twist the sawing wire approximately 1 to 1.5 turns counter-clockwise, as viewed toward the join. After each major cut, retwist the sawing wire with a different number of turns.
Wire breakage right beside the connector.	The wire passes round a sharply angled corner on the object being cut.	▶ Install additional guide pulleys to reduce the angle of deflection.
	Material fatigue of the sawing wire due to excessively long usage and aging.	▶ Use a new sawing wire.
	Material fatigue of the sawing wire due to excessive bending at the connector.	▶ Reduce bending of the wire with articulated connectors.
The sawing wire is pulled out of the connector.	Insufficient pressure applied to the crimping pliers.	▶ Use a press crimping tool rated for at least 8 t.
	Incorrect or worn crimping jaws.	▶ Check and, if necessary, replace the crimping jaws.



Trouble or fault	Possible cause	Action to be taken
The sawing wire is pulled out of the connector.	Sawing wire was not pushed far enough into the connector.	<ul style="list-style-type: none"> ▶ Push the sawing wire into the connector all the way to the front stop. ▶ Cut the sawing wire to length correctly and cleanly.
Sawing wire jumps and oscillates severely.	Insufficient wire tension.	▶ Increase the wire tension.
	The guide pulleys are too far apart (unsupported length of wire is too long).	<ul style="list-style-type: none"> ▶ Install additional pulley stands to reduce unsupported wire length. ▶ Position the wire saw closer to where the cut is being made. ▶ Install a shorter sawing wire.
Sawing wire vibrates very strongly at a high frequency.	The grooves between the wire guides and pivoting pulleys are not in alignment with each other.	▶ Bring the pivoting guide pulleys into alignment with the relay pulleys.
	Wire tension too high in relation to length of cut.	<ul style="list-style-type: none"> ▶ Increase the length of cut. ▶ Reduce tension on the wire.
Excessive sawing wire wear.	Wrong speed.	▶ Set the correct speed.
	Cutting speed, i.e. wire drive speed, is too low.	▶ Increase drive speed or cutting speed.
	Inadequate cooling of the sawing wire.	▶ Make sure that sufficient water is reaching the cut.
	Cutting or contact length too short.	▶ Increase the contact or cutting length.
	Wire tension too high in relation to length of cut.	<ul style="list-style-type: none"> ▶ Increase the length of cut. ▶ Reduce tension on the wire.
	Very abrasive material.	▶ Use different sawing wire specifications.

12 Fault codes

 Note down the fault code when you contact **Hilti** Service. This will make troubleshooting and fault rectification easier.

Malfunction	Possible cause	Action to be taken
Er100: Connection to the paired partner device lost.	Paired partner device not switched on or out of range.	▶ Switch the paired partner device on.
		▶ Reduce the distance between wireless remote control and drive unit.



Malfunction	Possible cause	Action to be taken
Er200: Wire storage unit full.	Cylinder extended to its maximum length.	▶ Stop the sawing operation and change the wire storage level. → page 29
		▶ Shorten the diamond wire.
		▶ Reposition the drive unit farther away from the cut.
Er202: Cover of the wire storage unit open.	Cover of the wire storage unit is not closed.	▶ Close the cover of the drive unit.
Er204: Electrical fault.	Fault in the electrical system.	▶ Switch the product off and then on again.
		▶ Contact Hilti Service.
Er205: Fault in the frequency converter.	Fault has occurred in the frequency converter.	▶ Switch the product off and then on again.
		▶ Contact Hilti Service.
Er206: Voltage too high.	Voltage of the AC supply is above the permissible range.	▶ Switch to a power source with permissible voltage values.
		▶ Contact the specialist for the electricity supply on the jobsite.
Er207: Automatic cut-out due to overload.	Sustained overload operation of the drive unit.	▶ Make sure that the diamond wire can pass freely through the cut.
		▶ Reduce the load on the motors.
Er208: Voltage too low.	Voltage of the AC supply is below the permissible range.	▶ Switch to a power source with permissible voltage values.
		▶ Use a shorter connecting cable with a heavier conductor cross-section.
		▶ Contact the specialist for the electricity supply on the jobsite.
Er209: Automatic cut-out due to overtemperature.	Temperature of the drive unit and electrics outside permissible range.	▶ Cool the drive unit with running cooling water.
		▶ Increase the flow rate of the cooling water.

13 Disposal

Most of the materials from which **Hilti** tools and appliances are manufactured can be recycled. The materials must be correctly separated before they can be recycled. In many countries, your old tools, machines or appliances can be returned to **Hilti** for recycling. Ask **Hilti** Service or your Hilti representative for further information.





-
- ▶ Do not dispose of power tools, electronic equipment or batteries as household waste!
-

14 Manufacturer's warranty

- ▶ Please contact your local **Hilti** representative if you have questions about the warranty conditions.







Hilti Corporation
Feldkircherstraße 100
9494 Schaan | Liechtenstein

Designation: Wire Saw

DSW 1510-CA (01)

2006/42/EC	EN 15027	EN 300328 V 2.1.1
2011/65/EU	EN 60204-1	EN 301489-1 V2.2.0
2014/53/EU		EN 301489-17 V3.2.0
		EN 62311: 2008

A handwritten signature in blue ink, appearing to read "Tahar Zrilli".

Dr. Tahar Zrilli

Head of Quality and Process Management
Business Area Electric Tools & Accessories

Schaan, 16.04.2021

A handwritten signature in blue ink, appearing to read "Johannes Wilfried Huber".

Johannes Wilfried Huber

Senior Vice President
Business Unit Diamond



Hilti Corporation

LI-9494 Schaan

Tel.:+423 234 21 11

Fax:+423 234 29 65

www.hilti.group



2238915